

**PIRTANO CONSTRUCTION  
PROPOSAL  
TO  
VILLAGE OF ORLAND PARK**

**FIBER BUILD TO POLICE  
TRAINING FACILITY  
RFP: 24-035**

# CONTENTS

- 1.) Technical Proposal
- 2.) Bid Bond
- 3.) Sections III Forms
  - a.) Summary Sheet
  - b.) Certificates of Compliance
  - c.) References
  - d.) Insurance
- 4.) Cut Sheets

# TECHNICAL PROPOSAL

## 1.) Experience and Operating History

PirTano Construction is a multi-dimensional construction company that has been in existence for over 40 years. We have built many types of utility projects including large sewer & water projects, conduits systems, fiber optic and coaxial systems. We are IDOT pre-qualified contractor (#4786). We are prequalified in the total amount of \$135,000,000.00

As a utility contractor we have constructed thousands of miles of communication networks. In 2014 we completed a 425 mile fiber network for lfiber in northwest Illinois. We have built distribution network for companies such as Comcast, AT&T, Verizon, Zayo and many others. We have years of experience providing installation services for single family, multi family, high rise, schools, hospitals, commercial buildings and campus environments. We offer complete turn key solutions including permitting, designs, aerial and underground construction, splicing and testing.

We are local Illinois contractor with our main office in Addison, Illinois. We also have offices located in Elk Grove, Volo, South Holland, Rochelle as well as Portage Indiana and Indianapolis Indiana.

We have a strong work force and management team that is highly committed to meeting and exceeding our customers requirements. Our reputation is for delivering quality projects on time.

## 2.) Qualifications/Personelle

### 1.) Don White - Vice President

Graduated in 1982 from University of Illinois with a B.S. in Civil Engineering. Has been with PirTano Construction for 40 years. He managed thousands of miles of fiber projects over the years.

### 2.) Adam Copot - Superintendent (Underground Construction)

Adam joined PirTano in 2023. Prior to this he was a superintendent for Tri-Tech Electric where he worked for 24 years. He was responsible for supervising all crews. He will be responsible for conduit placement.

### 3.) Gary Bose - Superintendent (Fiber Placement)

Gary has been with PirTano for over 30 years and supervises the aerial construction and fiber placement along with the splicing and testing.

### 4.) Chris Rempert - Fiber Splice

Chris has been splicing fiber for PirTano Construction for over 12 years. He is a IBEW certified splicer and has completed hundreds of miles of fiber projects.

## 5.) Tallman Consultant (Subcontractor, Design & Permit)

Talman is certified as a women's Business Enterprise (WBE) and Disadvantaged Business Enterprise (DBE) through the City of Chicago. This certification is accepted by other governmental agencies and private agencies as well. As a women-owned business, our emphasis on diversity yields new perspectives that result in competitive advantages for clients.

Talman's extensive experience in infrastructure management and utilities combined with its strong relationships with public, private and governmental entities enable Talman to negotiate the best possible time-to-market solution for getting work approved in the public right of way.

We specialize in utility design and partner with many industry-leading telecom, power, water, sewer and other utilities on large-scale, complex projects in urban and suburban areas.

Talman takes a 360 View of clients project lifecycle, breaking down silos to open channels of communications, uncovering opportunities and anticipating problems that are often missed. Our "Concept to Construction" service model ensures that client projects are "Designed to Build". Talman provides a complete range of services from design, project management, permit acquisition, construction oversight and restoration.

### 3.) Proposal Fee

#### a.) Scope of Work Pricing Sheet

##### 1.) Base Bid

<u>Bid Item</u>	<u>Qty</u>	<u>Unit Price</u>	<u>Total</u>
Bore 2-1 1/4"	4410 ft	24.25 /ft	106942.50
Hand hole installation	4 ea.	2105.00 ea.	8420.00
Rod duct/place 3-1 1/4"	4710 ft	8.40 ft	39564.00
Place 24ct fiber	5910 ft	2.90 ft	17139.00
Place 12ct fiber	5080 ft	2.60 ft	13208.00
Splice fiber	1 ea.	5415.00 ea.	5415.00
Permit & application fee	1 ea.	22000.00 ea.	22000.00
Performance Bond	1 ea.	1908.00 ea.	1908.00
			<hr/>
			214596.50

##### 2.) Alternate Bid

<u>Bid Item</u>	<u>Qty</u>	<u>Unit Price</u>	<u>Total</u>
Bore 2-1 1/4"	647 ft	31.15 /ft	20154.05
Repair Overflow HH	1 ea.	2500.00 ea.	2500.00
Handhole Installation	3 ft	2105.00 ft	6315.00
Rod Duct/place 3-1 1/4"	6225 ft	8.40 ft	52290.00
Place 12ct fiber	9470 ft	2.35 ft	22254.50
Splice Fiber	1 ea.	2005.00 ea.	2005.00
Permit application & fee	1 ea.	3300.00 ea.	3300.00
Performance Bond	1 ea.	896.00 ea.	896.00
			<hr/>
			109714.55

Grand Total 

---

---

324311.05

b.) Scope Of Work

1.) Base Bid

The conduit will be constructed as stated in the RFP. The new conduit will tie into an existing hand hole at the southwest corner of 159th St. and 104th Ave and continue to the Police Training Facilities. A new hand hole will be installed over the existing 4" conduit that feeds the Training Facility. A 24 count fiber will be placed from the hand hole at Ravinia and West Ave. to the hand hole at 159th & 104th Ave. A 12 count fiber will be placed from there to the Training facility. The fiber will be spliced and tested as required by the RFP.

2.) Alternate Bid

The conduit will be constructed from the existing hand hole at 159th St. to the existing conduit on the east side of the Sports Complex. See attached KMZ file. Comcast has utilized and Orland Park owned conduit to get their fiber into the equipment room. PirTano will install a hand hole over the existing conduit while maintaining the existing Comcast fiber. We will then pull the new 12 ct fiber into the equipment room. The fiber will be spliced and tested as required by the RFP.

c.) Schedule (Assumed Start Date of 8/1/24 for construction)

1.) Base Bid

	<u>Start</u>	<u>Complete</u>
> Permit Drawing and application	6/3/2024	7/26/2024
> Conduit Construction Base Bid	8/1/2024	8/16/2024
> Pull Innerduct in existing conduit	8/5/2024	8/9/2024
> Place Fiber 24ct	8/19/2024	8/20/2024
> Place Fiber 12ct (pending IT room)	2 days February 2025	
> Splice and Test	3 days February 2025	

2.) Alternate Bid

> Conduit Construction	8/19/2024	8/23/2024
> Pull Innerduct in existing conduit	8/12/2024	8/16/2024
> Place 12ct fiber	8/21/2024	8/23/2024
> Splice and test	8/26/2024	8/30/2024

# AIA<sup>®</sup> Document A310<sup>™</sup> – 2010

## **Bid Bond**

### **CONTRACTOR:**

*(Name, legal status and address)*

PirTano Construction Co. LLC  
1766 Armitage Court  
Addison IL 60101

### **SURETY:**

*(Name, legal status and principal place of business)*

Trisura Insurance Company  
2 Stamford Plaza, Suite 1504, 281 Tressor Blvd.  
Stamford, CT 06901

### **OWNER:**

*(Name, legal status and address)*

Village of Orland Park  
14700 S. Ravinia Avenue  
Orland Park, IL 60462

**BOND AMOUNT:** \$ 10% of Total Bid Amount (Ten Percent of Total Bid Amount)

### **PROJECT:**

*(Name, location or address, and Project number, if any)*

RFP #24-035  
Fiber Build to Orland Park Police Training Facility

### **ADDITIONS AND DELETIONS:**

The author of this document has added information needed for its completion. The author may also have revised the text of the original AIA standard form. An *Additions and Deletions Report* that notes added information as well as revisions to the standard form text is available from the author and should be reviewed. A vertical line in the left margin of this document indicates where the author has added necessary information and where the author has added to or deleted from the original AIA text.

This document has important legal consequences. Consultation with an attorney is encouraged with respect to its completion or modification.

Any singular reference to Contractor, Surety, Owner or other party shall be considered plural where applicable.

The Contractor and Surety are bound to the Owner in the amount set forth above, for the payment of which the Contractor and Surety bind themselves, their heirs, executors, administrators, successors and assigns, jointly and severally, as provided herein. The conditions of this Bond are such that if the Owner accepts the bid of the Contractor within the time specified in the bid documents, or within such time period as may be agreed to by the Owner and Contractor, and the Contractor either (1) enters into a contract with the Owner in accordance with the terms of such bid, and gives such bond or bonds as may be specified in the bidding or Contract Documents, with a surety admitted in the jurisdiction of the Project and otherwise acceptable to the Owner, for the faithful performance of such Contract and for the prompt payment of labor and material furnished in the prosecution thereof; or (2) pays to the Owner the difference, not to exceed the amount of this Bond, between the amount specified in said bid and such larger amount for which the Owner may in good faith contract with another party to perform the work covered by said bid, then this obligation shall be null and void, otherwise to remain in full force and effect. The Surety hereby waives any notice of an agreement between the Owner and Contractor to extend the time in which the Owner may accept the bid. Waiver of notice by the Surety shall not apply to any extension exceeding sixty (60) days in the aggregate beyond the time for acceptance of bids specified in the bid documents, and the Owner and Contractor shall obtain the Surety's consent for an extension beyond sixty (60) days.

If this Bond is issued in connection with a subcontractor's bid to a Contractor, the term Contractor in this Bond shall be deemed to be Subcontractor and the term Owner shall be deemed to be Contractor.

When this Bond has been furnished to comply with a statutory or other legal requirement in the location of the Project, any provision in this Bond conflicting with said statutory or legal requirement shall be deemed deleted herefrom and provisions conforming to such statutory or other legal requirement shall be deemed incorporated herein. When so furnished, the intent is that this Bond shall be construed as a statutory bond and not as a common law bond.

Init.

AIA Document A310<sup>™</sup> – 2010. Copyright © 1963, 1970 and 2010 by The American Institute of Architects. All rights reserved. **WARNING: This AIA<sup>®</sup> Document is protected by U.S. Copyright Law and International Treaties. Unauthorized reproduction or distribution of this AIA<sup>®</sup> Document, or any portion of it, may result in severe civil and criminal penalties, and will be prosecuted to the maximum extent possible under the law.** This document was produced by AIA software at 12:05:38 on 04/11/2011 under Order No.0544169414\_1 which expires on 02/16/2012, and is not for resale.

User Notes:

(1481917559)

Signed and sealed this 28<sup>th</sup> day of March, 2024

Deborah Mepper  
(Witness)

Nancy M. Zuck  
(Witness)

PirTano Construction Co. LLC  
(Contractor as Principal) (Seal)  
[Signature] PRESIDENT  
(Title)

Trisura Insurance Company  
(Surety) (Seal)  
Diana Baker  
(Title) Diana Baker (Attorney-in-Fact)

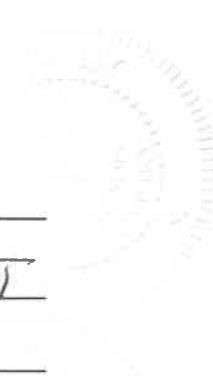

Init.



2 Stamford Plaza  
Suite 1504, 281 Tresser Boulevard  
Stamford, Connecticut 06901  
[us.surety@trisura.com](mailto:us.surety@trisura.com)

**POWER OF ATTORNEY**

Bond Number: \_\_\_\_\_  
Bond issuance date: March 28, 2024

**KNOW ALL MEN BY THESE PRESENTS:** That **TRISURA INSURANCE COMPANY**, a corporation organized and existing under the laws of the State of Oklahoma, authorized to conduct a surety business, and having its principal place of business at 2 Stamford Plaza, Suite 1504, Tresser Boulevard, Stamford, Connecticut 06901, does hereby constitute and appoint:

Paul F Praxmarer, Diana Baker

their true and lawful attorney(s)-in-fact to execute, seal and deliver for and on its behalf as surety, any and all bonds and undertakings, contracts of indemnity and other writings obligatory in the nature thereof, which are or may be allowed, required or permitted by law, statute, rule, regulation, contract or otherwise, and the execution of such instrument(s) in pursuance of these presents, shall be as binding upon the said **TRISURA INSURANCE COMPANY**, as fully and amply, to all intents and purposes, as if the same had been duly executed and acknowledged by their regularly elected officers at their principal offices.

This Power of Attorney is executed, and may be revoked, pursuant to and by authority of the By-Laws of **TRISURA INSURANCE COMPANY** and is granted under and by authority of the following resolution adopted by the Board of Directors of **TRISURA INSURANCE COMPANY** at a meeting duly held on the 11<sup>th</sup> day of December, 2020.

**"RESOLVED**, that (1) the Chief Executive Officer, President, Executive Vice President, Senior Vice President, Vice President, or Secretary of the Corporation shall have the power to appoint, and to revoke the appointments of, Attorneys-in-Fact or agents with power and authority as defined or limited in their respective powers of attorney, and to execute on behalf of the Corporation and affix the Corporation's seal thereto, bonds, undertakings, recognizances, contracts of indemnity and other written obligations in the nature thereof or related thereto; and (2) any such Officers of the Corporation may appoint and revoke the appointments of joint-control custodians, agents for acceptance of process, and Attorneys-in-fact with authority to execute waivers and consents on behalf of the Corporation; and (3) the signature of any such Officer of the Corporation and the Corporation's seal may be affixed by facsimile to any power of attorney or certification given for the execution of any bond, undertaking, recognizance, contract of indemnity or other written obligation in the nature thereof or related thereto, such signature and seals when so used whether heretofore or hereafter, being hereby adopted by the Corporation as the original signature of such officer and the original seal of the Corporation, to be valid and binding upon the Corporation with the same force and effect as though manually affixed."

IN WITNESS WHEREOF, **TRISURA INSURANCE COMPANY** have each executed and attested these presents  
on this 25<sup>th</sup> day of February, 2022.

STATE OF Connecticut  
County of Fairfield

George James, Chief Underwriting Officer, Surety



On this 25<sup>th</sup> day of February, 2022, before me came the individual who executed the preceding instrument, to me personally known, and, being by me duly sworn, said he is the therein described and authorized officer of **TRISURA INSURANCE COMPANY**; that the seals affixed to said instrument are the Corporate Seals of said Companies; that the said Corporate Seals and his signature were duly affixed by order of the Boards of Directors of said Companies.

IN TESTIMONY WHEREOF, I have hereunto set my hand affixed my Official Seal, at  
Fairfield, Connecticut the day and year first above written.

**SERENA I. SZEKELY** seal  
Notary Public, State of Connecticut  
My Commission Expires 10/31/2026  
MY Commission Expires: 10/31/2026

a Notary Public of Connecticut

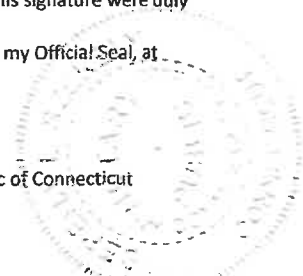

**CERTIFICATION**

I, the undersigned officer of **TRISURA INSURANCE COMPANY** do hereby certify that I have compared the foregoing copy of the Power of Attorney and affidavit, and the copy of the Sections of the By-Laws of said Companies as set forth in said Power of Attorney, with the originals on file in the home office of said companies, and that the same are correct transcripts thereof, and of the whole of the said originals, and that the said Power of Attorney has not been revoked and is now in full force and effect.

IN TESTIMONY WHEREOF, I have hereunto set my hand on this day,

Richard Grant, Vice President, U.S. Surety

TO CONFIRM AUTHENTICITY OF THIS BOND OR DOCUMENT EMAIL: [us.surety@trisura.com](mailto:us.surety@trisura.com)



# ACKNOWLEDGMENT OF CORPORATE SURETY

STATE OF ILLINOIS

County of Cook

On this 28<sup>th</sup> day of **March, 2024** before me appeared **Diana Baker** to me personally known, who being duly sworn, did say that he/she is the aforesaid officer or attorney in fact of **Trisura Insurance Company**, a corporation: that the seal affixed to the foregoing instrument is the corporate seal of said corporation, and that said instrument was signed and sealed on behalf of said corporation by the aforesaid officer (or Attorney-in-Fact), by authority of its Board of Directors; and the aforesaid officer (or Attorney-in-Fact), acknowledged said instrument to be the free act and deed of said corporation.

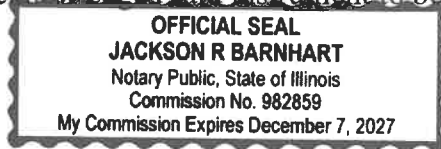

A handwritten signature in black ink, appearing to read "Jackson R. Barnhart", written over a horizontal line.

Notary Public

My Commission Expires:  
**December 7, 2027**

County of **DuPage**, State of **Illinois**

**PROPOSER SUMMARY SHEET**  
RFP 24-035  
Fiber Build to Police Training Facility

Business Name: Pirtano Construction LLC

Street Address: 1766 Armitage Ct,

City, State, Zip: Addison, IL 60101

Contact Name: Donald N. White

Title: Vice President

Phone: 630-932-1810 Fax: \_\_\_\_\_

E-Mail address: don.white@pirtano.com

**Price Proposal**

**BASE BID** \$ 214596.50

**ALTERNATE BID ONE** \$ 109714.55

**GRAND TOTAL PROPOSAL PRICE** \$ 324311.05

**AUTHORIZATION & SIGNATURE**

Name of Authorized Signee: Donald N. White

Signature of Authorized Signee: 

Title: Vice President Date: 3/27/2024

 **ORLAND PARK**  
**CERTIFICATE OF COMPLIANCE**

*Proposals shall complete this Certificate of Compliance. Failure to comply with all submission requirements may result in a determination that the Proposals is not responsible.*

The undersigned Donald N. White \_\_\_\_\_,  
(Enter Name of Person Making Certification)

as Vice President \_\_\_\_\_  
(Enter Title of Person Making Certification)

and on behalf of Pirtano Construction LLC \_\_\_\_\_,  
(Enter Name of Business Organization)

certifies that Proposers is:

1) **A BUSINESS ORGANIZATION:** Yes  No

**Federal Employer I.D. #:** 36-3176667  
(or Social Security # if a sole proprietor or individual)

The form of business organization of the Proposer is (check one):

- Sole Proprietor
- Independent Contractor (Individual)
- Partnership
- LLC
- Corporation \_\_\_\_\_ (State of Incorporation) \_\_\_\_\_ (Date of Incorporation)

2) **STATUS OF OWNERSHIP**

Illinois Public Act 102-0265, approved August 2021, requires the Village of Orland Park to collect "Status of Ownership" information. This information is collected for reporting purposes only. Please check the following that applies to the ownership of your business and include any certifications for the categories checked with the proposal. Business ownership categories are as defined in the Business Enterprise for Minorities, Women, and Persons with Disabilities Act, 30 ILCS 575/0.01 et seq.

- Minority-Owned
- Women-Owned
- Veteran-Owned
- Disabled-Owned
- Small Business  ([SBA standards](#))
- Prefer not to disclose
- Not Applicable

How are you certifying? Certificates Attached  Self-Certifying

**STATUS OF OWNERSHIP FOR SUBCONTRACTORS**

This information is collected for reporting purposes only. Please check the following that applies to the ownership of subcontractors.

Minority-Owned   
Women-Owned   
Veteran-Owned   
Disabled-Owned

Small Business  ([SBA standards](#))  
Prefer not to disclose   
Not Applicable

3) **AUTHORIZED TO DO BUSINESS IN ILLINOIS:** Yes  No

The Proposer is authorized to do business in the State of Illinois.

4) **ELIGIBLE TO ENTER INTO PUBLIC CONTRACTS:** Yes  No

The Proposer is eligible to enter into public contracts, and is not barred from contracting with any unit of state or local government as a result of a violation of either Section 33E-3, or 33E-4 of the Illinois Criminal Code, or of any similar offense of "bid-rigging" or "bid-rotating" of any state or of the United States.

5) **SEXUAL HARASSMENT POLICY COMPLIANT:** Yes  No

Please be advised that Public Act 87-1257, effective July 1, 1993, 775 ILCS 5/2-105 (A) has been amended to provide that every party to a public contract must have a written sexual harassment policy in place in full compliance with 775 ILCS 5/2-105 (A) (4) and includes, at a minimum, the following information:

(I) the illegality of sexual harassment; (II) the definition of sexual harassment under State law; (III) a description of sexual harassment, utilizing examples; (IV) the vendor's internal complaint process including penalties; (V) the legal recourse, investigative and complaint process available through the Department of Human Rights (the "Department") and the Human Rights Commission (the "Commission"); (VI) directions on how to contact the Department and Commission; and (VII) protection against retaliation as provided by Section 6-101 of the Act. (Illinois Human Rights Act). (emphasis added). Pursuant to 775 ILCS 5/1-103 (M) (2002), a "public contract" includes "...every contract to which the State, any of its political subdivisions or any municipal corporation is a party."

6) **EQUAL EMPLOYMENT OPPORTUNITY COMPLIANT:** Yes  No

During the performance of this Project, Proposer agrees to comply with the "Illinois Human Rights Act", 775 ILCS Title 5 and the Rules and Regulations of the Illinois Department of Human Rights published at 44 Illinois Administrative Code Section 750, et seq.

The Proposer shall:

(I) not discriminate against any employee or applicant for employment because of race, color, religion, sex, marital status, national origin or ancestry, age, or physical or mental handicap unrelated to ability, or an unfavorable discharge from military service; (II) examine all job classifications to determine if minority persons or women are underutilized and will take appropriate affirmative action to rectify any such underutilization; (III) ensure all solicitations or advertisements for employees placed by it or on its behalf, it will state that all applicants will be afforded equal opportunity without discrimination because of race, color, religion, sex, marital status, national origin or ancestry, age, or physical or mental handicap unrelated to ability, or an unfavorable discharge from military service; (IV) send to each labor organization or

representative of workers with which it has or is bound by a collective bargaining or other agreement or understanding, a notice advising such labor organization or representative of the Vendor's obligations under the Illinois Human Rights Act and Department's Rules and Regulations for Public Contract; (V) submit reports as required by the Department's Rules and Regulations for Public Contracts, furnish all relevant information as may from time to time be requested by the Department or the contracting agency, and in all respects comply with the Illinois Human Rights Act and Department's Rules and Regulations for Public Contracts; (VI) permit access to all relevant books, records, accounts and work sites by personnel of the contracting agency and Department for purposes of investigation to ascertain compliance with the Illinois Human Rights Act and Department's Rules and Regulations for Public Contracts; and (VII) include verbatim or by reference the provisions of this Equal Employment Opportunity Clause in every subcontract it awards under which any portion of this Agreement obligations are undertaken or assumed, so that such provisions will be binding upon such subcontractor.

In the same manner as the other provisions of this Agreement, the Proposer will be liable for compliance with applicable provisions of this clause by such subcontractors; and further it will promptly notify the contracting agency and the Department in the event any subcontractor fails or refuses to comply therewith. In addition, the Proposer will not utilize any subcontractor declared by the Illinois Human Rights Department to be ineligible for contracts or subcontracts with the State of Illinois or any of its political subdivisions or municipal corporations.

"Subcontract" means any agreement, arrangement or understanding, written or otherwise, between the Proposer and any person under which any portion of the Proposer's obligations under one or more public contracts is performed, undertaken or assumed; the term "subcontract", however, shall not include any agreement, arrangement or understanding in which the parties stand in the relationship of an employer and an employee, or between a Proposer or other organization and its customers.

In the event of the Proposer's noncompliance with any provision of this Equal Employment Opportunity Clause, the Illinois Human Right Act, or the Rules and Regulations for Public Contracts of the Department of Human Rights the Proposer may be declared non-responsible and therefore ineligible for future contracts or subcontracts with the State of Illinois or any of its political subdivisions or municipal corporations, and this agreement may be canceled or avoided in whole or in part, and such other sanctions or penalties may be imposed or remedies involved as provided by statute or regulation.

7) **PREVAILING WAGE COMPLIANCE:**      Yes     No

In the manner and to the extent required by law, this RFP is subject to the Illinois Prevailing Wage Act and to all laws governing the payment of wages to laborers, workers and mechanics of a Proposer or any subcontractor of a Proposer bound to this agreement who is performing services covered by this contract. If awarded the Contract, per 820 ILCS 130 et seq. as amended, Proposer shall pay not less than the prevailing hourly rate of wages, the generally prevailing rate of hourly wages for legal holiday and overtime work, and the prevailing hourly rate for welfare and other benefits as determined by the Illinois Department of Labor or the Village and as set forth in the schedule of prevailing wages for this contract to all laborers, workers and mechanics performing work under this contract (available at <https://www2.illinois.gov/idol/Laws-Rules/CONMED/Pages/Rates.aspx>).

The undersigned Proposer further stipulates and certifies that it has maintained a satisfactory record of Prevailing Wage Act compliance with no significant Prevailing Wage Act violations for

the past three (3) years.

Certified Payroll. The Illinois Prevailing Wage Act requires any contractor and each subcontractor who participates in public works to file with the Illinois Department of Labor (IDOL) certified payroll for those calendar months during which work on a public works project has occurred. The Act requires certified payroll to be filed with IDOL no later than the 15th day of each calendar month for the immediately preceding month through the Illinois Prevailing Wage Portal—an electronic database IDOL has established for collecting and retaining certified payroll. The Portal may be accessed using this link: <https://www2.illinois.gov/idol/Laws-Rules/CONMED/Pages/certifiedtranscriptofpayroll.aspx>. The Village reserves the right to withhold payment due to Contractor until Contractor and its subcontractors display compliance with this provision of the Act.

8) **PARTICIPATION IN APPRENTICESHIP AND TRAINING PROGRAM:**      Yes     No

Proposer participates in apprenticeship and training programs applicable to the work to be performed on the project, which are approved by and registered with the United States Department of Labor’s Office of Apprenticeship.

Name of A&T Program: Local 150 Apprenticeship

Brief Description of Program: We are signatory to Operators Union Local 150. Which

has an apprenticeship program.

---

---

---

---

---

9) **TAX COMPLIANT:**    Yes     No

Proposer is current in the payment of any tax administered by the Illinois Department of Revenue, or if it is not: (a) it is contesting its liability for the tax or the amount of tax in accordance with procedures established by the appropriate Revenue Act; or (b) it has entered into an agreement with the Department of Revenue for payment of all taxes due and is currently in compliance with that agreement.

**AUTHORIZATION & SIGNATURE:**

I certify that I am authorized to execute this Certificate of Compliance on behalf of the Proposer set forth on the Proposer Summary Sheet, that I have personal knowledge of all the information set forth herein and that all statements, representations, that the proposal is genuine and not collusive, and information provided in or with this Certificate are true and accurate.

The undersigned, having become familiar with the Project specified in this RFP, proposes to provide and furnish all of the labor, materials, necessary tools, expendable equipment and all

utility and transportation services necessary to perform and complete in a workmanlike manner all of the work required for the Project.

**ACKNOWLEDGED AND AGREED TO:**



\_\_\_\_\_  
Signature of Authorized Officer

Donald N. White

\_\_\_\_\_  
Name of Authorized Officer

Vice President

\_\_\_\_\_  
Title

3/27/2024

\_\_\_\_\_  
Date

## REFERENCES

Provide three (3) references for which your organization has performed similar work.

**Proposer's Name:** Pirtano Construction Co Inc  
(Enter Name of Business Organization)

1. ORGANIZATION Comcast  
ADDRESS 688 Industrial Drive, Elmhurst, IL 60126  
PHONE NUMBER 224-229-5861  
CONTACT PERSON Robert L. Schulter, Jr.  
YEAR OF PROJECT Ongoing construction since 1982
  
2. ORGANIZATION Northwestern University  
ADDRESS 2020 Ridge Ave. #342, Evanston, IL 60208  
PHONE NUMBER 847-366-9609  
CONTACT PERSON Doug Dickerson  
YEAR OF PROJECT 2024
  
3. ORGANIZATION Zayo  
ADDRESS 810 Jorie Blvd, Ste 110, Oak Brook, IL 60523  
PHONE NUMBER 630-991-7258  
CONTACT PERSON Tim Payment  
YEAR OF PROJECT 2023





# ORLAND PARK

## INSURANCE REQUIREMENTS

Please provide a policy Specimen Certificate of Insurance showing current coverage's along with this form

### WORKERS' COMPENSATION & EMPLOYER LIABILITY

Full Statutory Limits - Employers Liability  
\$500,000 – Each Accident \$500,000 – Each Employee  
\$500,000 – Policy Limit  
Waiver of Subrogation in favor of the Village of Orland Park

### AUTOMOBILE LIABILITY (ISO Form CA 0001)

\$1,000,000 – Combined Single Limit Per Occurrence  
Bodily Injury & Property Damage

### GENERAL LIABILITY (Occurrence basis) (ISO Form CG 0001)

\$1,000,000 – Combined Single Limit Per Occurrence  
Bodily Injury & Property Damage  
\$2,000,000 – General Aggregate Limit  
\$1,000,000 – Personal & Advertising Injury  
\$2,000,000 – Products/Completed Operations Aggregate  
Additional Insured Endorsements: (not applicable for Goods Only)  
ISO CG 20 10 or CG 20 26  
**and**  
CG 20 01 Primary & Non-Contributory  
Blanket Waiver of Subrogation in favor of the Village of Orland Park

CG 20 37 Additional Insured – Completed Operations (provide if box is checked)

*In addition to the above, please provide the following coverage, if box is checked.*

**LIABILITY UMBRELLA (Follow Form Policy)**  
 \$1,000,000 – Each Occurrence \$1,000,000 – Aggregate  
 \$2,000,000 – Each Occurrence \$2,000,000 – Aggregate  
 Other: \_\_\_\_\_

**EXCESS MUST COVER:** General Liability, Automobile Liability, Employers' Liability

**PROFESSIONAL LIABILITY**  
 \$1,000,000 Limit – Claims Made Form, Indicate Retroactive Date  
 \$2,000,000 Limit – Claims Made Form, Indicate Retroactive Date  
 Other: \_\_\_\_\_  
Deductible not-to-exceed \$50,000 without prior written approval

**BUILDERS RISK**  
Completed Property Full Replacement Cost Limits – Structures under construction

**ENVIRONMENTAL IMPAIRMENT/POLLUTION LIABILITY**  
\$1,000,000 Limit for bodily injury, property damage and remediation costs  
resulting from a pollution incident at, on or mitigating beyond the job site

**CYBER LIABILITY**  
\$1,000,000 Limit per Data Breach for liability, notification, response,  
credit monitoring service costs, and software/property damage

Any insurance policies providing the coverages required of the Consultant, excluding Professional Liability, shall be specifically endorsed to identify "The Village of Orland Park, and their respective officers, trustees, directors, officials, employees, volunteers and agents as Additional Insureds on a primary/non-contributory basis with respect to all claims arising out of operations by or on behalf of the named insured." The required

Additional Insured coverage shall be provided on the Insurance Service Office (ISO) CG 20 10 or CG 20 26 endorsements or an endorsement at least as broad as the above noted endorsements as determined by the Village of Orland Park. Any Village of Orland Park insurance coverage shall be deemed to be on an excess or contingent basis as confirmed by the required (ISO) CG 20 01 Additional Insured Primary & Non-Contributory Endorsement. The policies shall also contain a Waiver of Subrogation in favor of the Additional Insureds in regard to General Liability and Workers' Compensation coverage. The certificate of insurance shall also state this information on its face. Any insurance company providing coverage must hold an A-, VII rating according to Best's Key Rating Guide. Each insurance policy required shall have the Village of Orland Park expressly endorsed onto the policy as a Cancellation Notice Recipient. Should any of the policies be cancelled before the expiration date thereof, notice will be delivered in accordance with the policy provisions. Permitting the contractor, or any subcontractor, to proceed with any work prior to our receipt of the foregoing certificate and endorsements shall not be a waiver of the contractor's obligation to provide all the above insurance.

Consultant agrees that prior to any commencement of work to furnish evidence of Insurance coverage providing for at minimum the coverages, endorsements and limits described above directly to the Village of Orland Park, 14700 S. Ravinia Avenue, Orland Park, IL 60462. Failure to provide this evidence in the time frame specified and prior to beginning of work may result in the termination of the Village's relationship with the contractor.

ACCEPTED & AGREED THIS 27<sup>th</sup> DAY OF MARCH, 2024

Donald N. White

Signature

DONALD N. WHITE

Printed Name & Title

Authorized to execute agreements for:

PIRTANO CONSTRUCTION

Name of Company

**THIS ENDORSEMENT CHANGES THE POLICY. PLEASE READ IT CAREFULLY.**

**ADDITIONAL INSURED - OWNERS, LESSEES OR  
CONTRACTORS - SCHEDULED PERSON OR  
ORGANIZATION**

This endorsement modifies insurance provided under the following:

COMMERCIAL GENERAL LIABILITY COVERAGE PART

**SCHEDULE**

Name Of Additional Insured Person(s) Or Or _____	Location s Of Covered O erations
	
Information re uired to com plete this Schedule, f:ttfshown above, will be shown in the Declarations.	

**A. Section II - Who Is An Insured** is' r,naed to include as an additional insure,d\_1be person(s) or organization(s) shown in the {Sc gite, ,but only with respect to liability for "bodlly\_1njury"i "property damage" or "personal and ady r\$sing injury" caused, in whole or in part, by:

1. Your acts or omissions; or
2. The acts or omissions of those acting on your behalf;

in the performance of your ongoing operations for the additional insured(s) at the location(s) designated above.

**B.** With respect to the insurance afforded to these additional insureds, the following additional exclusions apply:

This insurance does not apply to "bodily injury" or "property damage" occurring after:

1. All work, including materials, parts or equipment furnished in connection with such work, on the project (other than service, maintenance or repairs) to be performed by or on behalf of the additional insured(s) at the location of the covered operations has been completed; or
2. That portion of "your work" out of which the injury or damage arises has been put to its intended use by any person or organization other than another contractor or subcontractor engaged in performing operations for a principal as a part of the same project.



POLICY NUMBER:

COMMERCIAL GENERAL LIABILITY  
CG 20 26 07 04

**THIS ENDORSEMENT CHANGES THE POLICY. PLEASE READ IT CAREFULLY.**

## **ADDITIONAL INSURED - DESIGNATED PERSON OR ORGANIZATION**

This endorsement modifies insurance provided under the following:

COMMERCIAL GENERAL LIABILITY COVERAGE PART

### **SCHEDULE**

**Name Of Additional Insured Person(s) Or Organization(s)**

--

Information required to complete this Schedule - if not shown above, will be shown in the Declarations.

**A'**

**Section II - Who Is An Insured:** is permitted to include as an additional insured the person(s) or organization(s) shown in the Schedule. In addition, with respect to liability for "bodily injury", "property damage" or "personal and advertising injury" caused, in whole or in part, by your acts or omissions or the acts or omissions of those acting on your behalf:

- A. In the performance of your ongoing operations; or
- B. In connection with your premises owned by or rented to you.



**THIS ENDORSEMENT CHANGES THE POLICY. PLEASE READ IT CAREFULLY.**

**ADDITIONAL INSURED - OWNERS, LESSEES OR  
CONTRACTORS -AUTOMATIC STATUS WHEN  
REQUIRED IN CONSTRUCTION AGREEMENT WITH YOU**

This endorsement modifies insurance provided under the following:

COMMERCIAL GENERAL LIABILITY COVERAGE PART

**A. Section II - Who Is An Insured** is amended to include as an additional insured any person or organization for whom you are performing operations when you and such person or organization have agreed in writing in a contract or agreement that such person or organization be added as an additional insured on your policy. Such person or organization is an additional insured only with respect to liability for "bodily injury", "property damage" or "personal and advertising injury" caused, in whole or in part, by:

- 1. Your acts or omissions; or
- 2. The acts or omissions of those acting on your behalf;

in the performance of your ongoing operations for the additional insured.

However, the insurance afforded to such additional insured:

- 1. Only applies to the extent permitted by law; and
- 2. Will not be broader than that which you are required by the contract or agreement to provide for such additional insured.

A person's or organization's status as an additional insured under this endorsement ends when your operations for that additional insured are completed.

**B.** With respect to the insurance afforded to these additional insureds, the following additional exclusions apply:

This insurance does not apply to:

- 1. "Bodily injury", "property damage" or "personal and advertising injury" arising out of the rendering of, or the failure to render,

any professional architectural, engineering or surveying services, including:

- a. The preparing, approving, or failing to prepare or approve, maps, shop drawings, opinions, reports, surveys, field orders, change orders or drawings and specifications; or
- b. Supervisory, inspection, architectural or engineering activities.

This exclusion applies even if the claims against any insured allege negligence or other wrongdoing in the supervision, hiring, employment, training or monitoring of others by that insured, if the "occurrence" which caused the "bodily injury" or "property damage", or the offense which caused the "personal and advertising injury", involved the rendering of or the failure to render any professional architectural, engineering or surveying services.

2. "Bodily injury" or "property damage" occurring after:

- a. All work, including materials, parts or equipment furnished in connection with such work, on the project (other than service, maintenance or repairs) to be performed by or on behalf of the additional insured(s) at the location of the covered operations has been completed; or
- b. That portion of "your work" out of which the injury or damage arises has been put to its intended use by any person or organization other than another contractor or subcontractor engaged in

**THIS ENDORSEMENT CHANGES THE POLICY. PLEASE READ IT CAREFULLY.**

## **ADDITIONAL INSURED - OWNERS, LESSEES OR CONTRACTORS- COMPLETED OPERATIONS**

This endorsement modifies insurance provided under the following:

COMMERCIAL GENERAL LIABILITY COVERAGE PART

### **SCHEDULE**

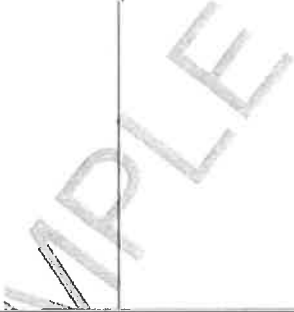
Name Of Additional Insured Person(s) Or Organization(s)	Location And Description Of Completed Operations
	
Information required to complete this Schedule, if not shown above, will be shown in the Declarations.	

**Section II - Who Is An Insured** - is amended to include as an additional insured the person(s) or organization(s) shown in the Schedule; but, only with respect to liability for "bodily injury; or" "property damage" caused, in whole or in part, by "your work" at the location designated and described in the schedule of this endorsement performed for that additional insured and included in the "products-completed operations hazard".





PIRTCON-01

DSOMMERS

# CERTIFICATE OF LIABILITY INSURANCE

DATE (MM/DD/YYYY)

3/8/2024

THIS CERTIFICATE IS ISSUED AS A MATTER OF INFORMATION ONLY AND CONFERS NO RIGHTS UPON THE CERTIFICATE HOLDER. THIS CERTIFICATE DOES NOT AFFIRMATIVELY OR NEGATIVELY AMEND, EXTEND OR ALTER THE COVERAGE AFFORDED BY THE POLICIES BELOW. THIS CERTIFICATE OF INSURANCE DOES NOT CONSTITUTE A CONTRACT BETWEEN THE ISSUING INSURER(S), AUTHORIZED REPRESENTATIVE OR PRODUCER, AND THE CERTIFICATE HOLDER.

**IMPORTANT:** If the certificate holder is an **ADDITIONAL INSURED**, the policy(ies) must have **ADDITIONAL INSURED** provisions or be endorsed. If **SUBROGATION IS WAIVED**, subject to the terms and conditions of the policy, certain policies may require an endorsement. A statement on this certificate does not confer rights to the certificate holder in lieu of such endorsement(s).

<b>PRODUCER</b> AssuredPartners of IL, LLC 25 Northwest Point Blvd., Ste 625 Elk Grove Village, IL 60007	<b>CONTACT NAME:</b> <b>PHONE (A/C, No, Ext):</b> (847) 758-1000 <b>FAX (A/C, No):</b> (847) 758-1200 <b>E-MAIL ADDRESS:</b>  <table border="1" style="width: 100%; border-collapse: collapse;"> <tr> <th colspan="2" style="text-align: center;">INSURER(S) AFFORDING COVERAGE</th> <th style="text-align: center;">NAIC #</th> </tr> <tr> <td style="width: 80%;">INSURER A: <b>Union Insurance Company</b></td> <td colspan="2" style="text-align: center;"><b>25844</b></td> </tr> <tr> <td>INSURER B:</td> <td colspan="2"></td> </tr> <tr> <td>INSURER C:</td> <td colspan="2"></td> </tr> <tr> <td>INSURER D:</td> <td colspan="2"></td> </tr> <tr> <td>INSURER E:</td> <td colspan="2"></td> </tr> <tr> <td>INSURER F:</td> <td colspan="2"></td> </tr> </table>	INSURER(S) AFFORDING COVERAGE		NAIC #	INSURER A: <b>Union Insurance Company</b>	<b>25844</b>		INSURER B:			INSURER C:			INSURER D:			INSURER E:			INSURER F:		
INSURER(S) AFFORDING COVERAGE		NAIC #																				
INSURER A: <b>Union Insurance Company</b>	<b>25844</b>																					
INSURER B:																						
INSURER C:																						
INSURER D:																						
INSURER E:																						
INSURER F:																						
<b>INSURED</b>  <b>PirTano Construction Company, LLC</b> 1766 Armitage Court Addison, IL 60101																						

**COVERAGES**    **CERTIFICATE NUMBER: 030824**    **REVISION NUMBER:**

THIS IS TO CERTIFY THAT THE POLICIES OF INSURANCE LISTED BELOW HAVE BEEN ISSUED TO THE INSURED NAMED ABOVE FOR THE POLICY PERIOD INDICATED. NOTWITHSTANDING ANY REQUIREMENT, TERM OR CONDITION OF ANY CONTRACT OR OTHER DOCUMENT WITH RESPECT TO WHICH THIS CERTIFICATE MAY BE ISSUED OR MAY PERTAIN, THE INSURANCE AFFORDED BY THE POLICIES DESCRIBED HEREIN IS SUBJECT TO ALL THE TERMS, EXCLUSIONS AND CONDITIONS OF SUCH POLICIES. LIMITS SHOWN MAY HAVE BEEN REDUCED BY PAID CLAIMS.

INSR LTR	TYPE OF INSURANCE	ADDL INSD	SUBR WVD	POLICY NUMBER	POLICY EFF (MM/DD/YYYY)	POLICY EXP (MM/DD/YYYY)	LIMITS	
A	<input checked="" type="checkbox"/> <b>COMMERCIAL GENERAL LIABILITY</b> <input type="checkbox"/> CLAIMS-MADE <input checked="" type="checkbox"/> OCCUR  GEN'L AGGREGATE LIMIT APPLIES PER: <input type="checkbox"/> POLICY <input checked="" type="checkbox"/> PROJECT <input type="checkbox"/> LOC OTHER:			CPA 3257322	5/1/2023	5/1/2024	EACH OCCURRENCE	\$ 1,000,000
							DAMAGE TO RENTED PREMISES (Ea occurrence)	\$ 300,000
							MED EXP (Any one person)	\$ 10,000
							PERSONAL & ADV INJURY	\$ 1,000,000
							GENERAL AGGREGATE	\$ 2,000,000
							PRODUCTS - COMP/OP AGG	\$ 2,000,000
							UM/UIIM	\$
A	<input checked="" type="checkbox"/> <b>AUTOMOBILE LIABILITY</b> <input checked="" type="checkbox"/> ANY AUTO OWNED AUTOS ONLY <input type="checkbox"/> SCHEDULED AUTOS <input checked="" type="checkbox"/> HIRED AUTOS ONLY <input checked="" type="checkbox"/> NON-OWNED AUTOS ONLY			CPA 3257322	5/1/2023	5/1/2024	COMBINED SINGLE LIMIT (Ea accident)	\$ 1,000,000
							BODILY INJURY (Per person)	\$
							BODILY INJURY (Per accident)	\$
							PROPERTY DAMAGE (Per accident)	\$
A	<input checked="" type="checkbox"/> <b>UMBRELLA LIAB</b> <input checked="" type="checkbox"/> OCCUR <input type="checkbox"/> EXCESS LIAB <input type="checkbox"/> CLAIMS-MADE DED <input checked="" type="checkbox"/> RETENTION \$ 0			CPA 3257322	5/1/2023	5/1/2024	EACH OCCURRENCE	\$ 10,000,000
							AGGREGATE	\$ 10,000,000
A	<b>WORKERS COMPENSATION AND EMPLOYERS' LIABILITY</b> ANY PROPRIETOR/PARTNER/EXECUTIVE OFFICER/MEMBER EXCLUDED? (Mandatory in NH) <input checked="" type="checkbox"/> Y <input type="checkbox"/> N    N/A If yes, describe under DESCRIPTION OF OPERATIONS below			WCA 3275759	5/1/2023	5/1/2024	<input checked="" type="checkbox"/> PER STATUTE <input type="checkbox"/> OTH-ER	\$
							E.L. EACH ACCIDENT	\$ 1,000,000
							E.L. DISEASE - EA EMPLOYEE	\$ 1,000,000
							E.L. DISEASE - POLICY LIMIT	\$ 1,000,000

**DESCRIPTION OF OPERATIONS / LOCATIONS / VEHICLES (ACORD 101, Additional Remarks Schedule, may be attached if more space is required)**  
 The Village of Orland Park, and their respective officers, trustees, directors, officials, employees, volunteers and agents are Additional Insured for General Liability on a primary and non-contributory basis if required by written contract. A waiver of subrogation applies in favor of the General Liability and Workers Compensation if required by written contract. Umbrella follows form of the General Liability, Auto Liability, and Employers Liability. CLCG2079 0620, CLCG0492 1018, WC000313 0484

**CERTIFICATE HOLDER****CANCELLATION**

<b>Village of Orland Park</b> 14700 S. Ravinia Avenue Orland Park, IL 60462	SHOULD ANY OF THE ABOVE DESCRIBED POLICIES BE CANCELLED BEFORE THE EXPIRATION DATE THEREOF, NOTICE WILL BE DELIVERED IN ACCORDANCE WITH THE POLICY PROVISIONS.  AUTHORIZED REPRESENTATIVE 
---	---

THIS ENDORSEMENT CHANGES THE POLICY. PLEASE READ IT CAREFULLY.

## CONTRACTORS ADDITIONAL INSURED WHILE UNDER CONTRACT COVERAGE

This endorsement modifies insurance provided under the following:

### COMMERCIAL GENERAL LIABILITY COVERAGE PART

#### A. Ongoing Operations

1. **SECTION II - WHO IS AN INSURED** is amended to include as an additional insured:

- a. Any person or organization for whom you are performing operations when you and such person or organization have agreed in a written contract or written agreement that such person or organization be added as an additional insured on your policy with respect to your ongoing operations; and
- b. Any other person or organization, including any architects, engineers or surveyors not engaged by you, whom you are required to add as an additional insured under your policy in the contract or agreement in Paragraph **A.1.a.** above.

2. With respect to the insurance afforded to the additional insured under Paragraphs **A.1.a.** and **A.1.b.** above, the following limitations apply:

- a. If the written contract or written agreement requires you to add that person or organization as an additional insured to your policy with respect to **liability arising out of** your ongoing operations, then such person or organization is an additional insured, but only with respect to **liability arising out of** your ongoing operations performed under the written contract or written agreement.
- b. If the written contract or written agreement does not require you to add that person or organization as an additional insured to your policy with respect to **liability arising out of** your ongoing operations, then such person or organization is an additional insured, but only with respect to "bodily injury", "property damage" or "personal and advertising injury" **caused in whole or in part by** your ongoing operations

performed under the written contract or written agreement.

#### B. Completed Operations:

1. **SECTION II - WHO IS AN INSURED** is amended to include as an additional insured:

- a. Any person or organization for whom you are performing operations when you and such person or organization have agreed in a written contract or written agreement that such person or organization be added as an additional insured on your policy with respect to "your work" included in the "product-completed operations hazard"; and
- b. Any other person or organization, including any architects, engineers or surveyors not engaged by you, whom you are required to add as an additional insured under your policy in the contract or agreement in Paragraph **B.1.a.** above.

2. With respect to the insurance afforded to the additional insured under Paragraphs **B.1.a.** and **B.1.b.** above, the following limitations apply:

- a. If the written contract or written agreement requires you to add that person or organization as an additional insured to your policy with respect to **liability arising out of** "your work" and included in the "products-completed operations hazard", then such person or organization is an additional insured, but only with respect to **liability arising out of** "your work" performed under the written contract or written agreement and included in the "products-completed operations hazard".
- b. If the written contract or written agreement does not require you to add that person or organization as an additional insured to your policy with respect to **liability arising out of** "your work" and included in the



"products-completed operations hazard", then such person or organization is an additional insured, but only with respect to "bodily injury", "property damage", or "personal and advertising injury" **caused in whole or in part by** "your work" performed under the written contract or written agreement and included in the "products-completed operations hazard".

**C. The coverages provided in Paragraphs A. Ongoing Operations and B. Completed Operations:**

1. Do not apply unless the written contract or written agreement has been fully executed by all parties prior to when any "bodily injury", "property damage", or "personal advertising injury" first occurs;
2. Only apply to the extent permitted by law; and
3. Will not be broader than that which you are required by the contract or agreement to provide for such additional insured.

**D. Exclusions**

1. With respect to the insurance afforded to the additional insured under Paragraph **A. Ongoing Operations**, the following exclusion applies:

This insurance does not apply to "bodily injury", "property damage", or "personal and advertising injury" occurring after:

- a. All work, including materials, parts or equipment furnished in connection with such work on the project, (other than service; maintenance or repairs) to be performed by or on behalf of the additional insured(s) at the site of the covered operations has been completed; or
- b. That portion of "your work" out of which the injury or damage arises has been put to its intended use by any person or organization other than another contractor or subcontractor engaged in performing operations for a principal as part of the same project.

2. With respect to the insurance afforded to the additional insured under Paragraphs **A. Ongoing Operations** and **B. Completed Operations**, the following exclusion applies:

This insurance does not apply to "bodily injury", "property damage", or "personal and advertising injury" **arising out of** the rendering of, or failure to render, any professional architectural, engineering, or surveying services, including:

- a. The preparing, approving, or failing to prepare or approve maps, shop drawings, opinions, reports, surveys, field orders,

change orders, or drawings and specifications, or

- b. Supervisory, inspection, architectural, or engineering services.

**E. With respect to the insurance afforded to the additional insured under Paragraphs A. Ongoing Operations and B. Completed Operations, the following is added to SECTION III - LIMITS OF INSURANCE:**

1. The most we will pay on behalf of the additional insured is the amount of insurance:

- a. Required by the written contract or written agreement; or
- b. Available under the applicable limits of insurance shown in the Declarations;

Whichever is less.

This endorsement shall not increase the applicable Limits of Insurance shown in the Declarations.

**F. With respect to the insurance afforded to the additional insured under Paragraphs A. Ongoing Operations and B. Completed Operations, the following is added to Paragraph 4.a. Other Insurance of SECTION IV - COMMERCIAL GENERAL LIABILITY CONDITIONS and supersedes any provision to the contrary:**

1. This insurance is primary to and will not seek contribution from any other insurance available to the additional insured under the policy provided that:

- a. The additional insured is a Named Insured under such other insurance; and
- b. You have agreed in writing in a contract or agreement that this insurance would be primary and would not seek contribution from any other insurance available to the additional insured.

All other provisions, conditions, and exclusions of the policy remain unchanged.

**THIS ENDORSEMENT CHANGES THE POLICY. PLEASE READ IT CAREFULLY.**

## **GENERAL LIABILITY ULTRA PLUS ENDORSEMENT**

This endorsement modifies insurance provided under the following:

COMMERCIAL GENERAL LIABILITY COVERAGE PART

### **SUMMARY OF COVERAGE EXTENSIONS**

<b>Provision</b>	<b>Name Of Coverage Extension</b>	<b>Included or Limit of Insurance</b>
<b>A.</b>	Miscellaneous Additional Insureds	Included
<b>B.</b>	Expected Or Intended Injury Or Damage	Included
<b>C.</b>	Knowledge Of Occurrence	Included
<b>D.</b>	Legal Liability – Damage To Premises Rented To You (Fire, Lightning, Explosion, Smoke, Or Leakage From Automatic Fire Protective Systems)	\$300,000
<b>E.</b>	Medical Payments	See Declarations
<b>F.</b>	Mobile Equipment Redefined	Included
<b>G.</b>	Newly Formed Or Acquired Organization, Partnership Or Limited Liability Company And Extended Period Of Coverage	Included
<b>H.</b>	Who Is An Insured – Amendment	Included
<b>I.</b>	Non-Owned Watercraft (Increased to maximum length of less than 51 feet)	Included
<b>J.</b>	Supplementary Payments – Increased Limits	
	1. Bail Bonds	\$ 3,000
	2. Loss Of Earnings	\$ 1,000
<b>K.</b>	Unintentional Omission Or Unintentional Error In Disclosure	Included
<b>L.</b>	Waiver Of Transfer Of Rights Of Recovery Against Others	Included
<b>M.</b>	Liberalization Clause	Included
<b>N.</b>	Incidental Medical Malpractice	Included

The above is a summary only. Please consult the specific provisions that follow for complete information on the extensions provided.

The provisions of the Commercial General Liability Coverage Part apply except as otherwise provided in this endorsement. This endorsement applies only if such Coverage Part is included in this policy.

#### **A. MISCELLANEOUS ADDITIONAL INSUREDS**

1. **Section II – Who Is An Insured** is amended to include as an insured any person or organization (referred to as an additional insured below) described in Paragraphs **A.1.c.(1)** through **A.1.c.(9)** below when you and such person or organization have agreed

in writing in a contract or agreement that such person or organization be added as an additional insured on your policy, provided that:

- a. The written contract or written agreement is:
  - (1) Currently in effect or becoming effective during the term of this policy; and
  - (2) Fully executed by you and the additional insured prior to the "bodily

injury", "property damage" or "personal and advertising injury".

- b. The insurance afforded by this provision does not apply to any person or organization included as an additional insured by a separate endorsement issued by us and made a part of this policy or coverage part.
- c. Only the following persons or organizations are additional insureds under this provision, with coverage for such additional insureds limited as provided herein:

**(1) Persons or Organizations For Whom Operations Are Performed**

- (a) Any person or organization for whom you are performing operations when you and such person or organization have agreed in writing in a contract or agreement that such person or organization be added as an additional insured to your policy; and
- (b) Any other person or organization you are required to add as an additional insured under the contract or agreement described in paragraph (a) above.
- (c) Such person(s) or organization(s) is an additional insured only with respect to liability for "bodily injury", "property damage" or "personal and advertising injury" caused, in whole or in part, by:
  - (i) Your acts or omissions; or
  - (ii) The acts or omissions of those acting on your behalf;

in the performance of your ongoing operations for the additional insured.

- (d) With respect to the insurance afforded to these additional insureds, the following additional exclusions apply:

This insurance does not apply to:

- (i) "Bodily injury", "property damage" or "personal and advertising injury" arising out of the rendering of, or the failure to render, any professional architectural, engineering or surveying services, including:

(1.1) The preparing, approving, or failing to prepare or approve, maps, shop drawings, opinions, reports, surveys, field orders, change orders or drawings and specifications; or

(1.2) Supervisory, inspection, architectural or engineering activities.

This exclusion applies even if the claims against any insured allege negligence or other wrongdoing in the supervision, hiring, employment, training or monitoring of others by that insured, if the "occurrence" which caused the "bodily injury" or "property damage", or the offense which caused the "personal and advertising injury", involved the rendering of, or the failure to render, any professional architectural, engineering or surveying services.

(ii) "Bodily injury" or "property damage" occurring after:

(1.1) All work, including materials, parts or equipment furnished in connection with such work, on the project (other than service, maintenance or repairs) to be performed by or on behalf of the additional insured(s) at the location of the covered operations has been completed; or

(1.2) That portion of "your work" out of which the injury or damage arises has been put to its intended use by any person or organization other than another contractor or subcontractor engaged in performing operations for a principal as a part of the same project.

**(2) Managers Or Lessors Of Premises**

A manager or lessor of premises but only with respect to liability arising out of the ownership, maintenance or use of that part of the premises leased to

you and subject to the following additional exclusions:

This insurance does not apply to:

- (a) Any "occurrence" which takes place after you cease to be a tenant in that premises.
- (b) Structural alterations, new construction or demolition operations performed by or on behalf of such additional insured.

**(3) Mortgagee, Assignee Or Receiver**

A mortgagee, assignee, or receiver but only with respect to their liability as mortgagee, assignee, or receiver and arising out of the ownership, maintenance, or use of a covered premises by you.

This insurance does not apply to structural alterations, new construction or demolition operations performed by or on behalf of such additional insured.

**(4) Owners Or Other Interests From Whom Land Has Been Leased**

An owner or other interest from whom land has been leased to you but only with respect to liability arising out of the ownership, maintenance or use of that part of the land leased to you and subject to the following additional exclusions:

This insurance does not apply to:

- (a) Any "occurrence" which takes place after you cease to lease that land.
- (b) Structural alterations, new construction or demolition operations performed by or on behalf of such additional insured.

**(5) Lessor Of Leased Equipment**

Any person(s) or organization(s) from whom you lease equipment but only with respect to liability for "bodily injury", "property damage" or "personal and advertising injury" caused, in whole or in part, by your maintenance, operation or use of equipment leased to you by such person(s) or organization(s).

A person's or organization's status as an additional insured under this endorsement ends when their written

contract or written agreement with you for such leased equipment ends.

This insurance does not apply to any "occurrence" which takes place after the equipment lease expires.

**(6) State, Municipality, Governmental Agency Or Subdivision Or Other Political Subdivision – Permits Or Authorizations Relating To Premises**

Any state, municipality, governmental agency or subdivision or other political subdivision subject to the following additional provisions:

(a) This insurance applies only with respect to:

(i) The following hazards for which the state, municipality, governmental agency or subdivision or other political subdivision has issued a permit or authorization in connection with premises you own, rent or control and to which this insurance applies:

(1.1) The existence, maintenance, repair, construction, erection or removal of advertising signs, awnings, canopies, cellar entrances, coal holes, driveways, manholes, marquees, hoist away openings, sidewalk vaults, street banners or decorations and similar exposures; or

(1.2) The construction, erection or removal of elevators; or

(1.3) The ownership, maintenance or use of any elevators covered by this insurance.

(ii) Operations performed by you or on your behalf for which the state, municipality, governmental agency or subdivision or other political subdivision has issued a permit or authorization.

- (b) This insurance does not apply to "bodily injury", "property damage" or "personal and advertising injury" arising out of operations performed for the state, municipality, governmental agency or subdivision or other political subdivision.

**(7) Controlling Interest**

Any person(s) or organization(s) with a controlling interest in the Named Insured but only with respect to their liability arising out of:

- (a) Their financial control of you; or
- (b) Premises they own, maintain or control while you lease or occupy these premises.

This insurance does not apply to structural alterations, new construction or demolition operations performed by or for such person(s) or organization(s).

**(8) Co-Owner Of Insured Premises**

A co-owner of a premises co-owned by you and covered under this insurance but only with respect to the co-owner's liability as co-owner of such premises.

**(9) Vendors**

- (a) Any person(s) or organization(s) (referred to as vendor), but only with respect to "bodily injury" or "property damage" arising out of "your products" which are distributed or sold in the regular course of the vendor's business.

The insurance afforded the vendor does not apply to:

- (i) "Bodily injury" or "property damage" for which the vendor is obligated to pay damages by reason of the assumption of liability in a written contract or written agreement. This exclusion does not apply to liability for damages that the vendor would have in the absence of the written contract or written agreement;
- (ii) Any express warranty unauthorized by you;

- (iii) Any physical or chemical change in the product made intentionally by the vendor;

- (iv) Repackaging, except when unpacked solely for the purpose of inspection, demonstration, testing, or the substitution of parts under instructions from the manufacturer, and then repackaged in the original container;

- (v) Any failure to make such inspections, adjustments, tests or servicing as the vendor has agreed to make or normally undertakes to make in the usual course of business, in connection with the distribution or sale of the products;

- (vi) Demonstration, installation, servicing or repair operations, except such operations performed at the vendor's premises in connection with the sale of the product;

- (vii) Products which, after distribution or sale by you, have been labeled or relabeled or used as a container, part or ingredient of any other thing or substance by or for the vendor; or

- (viii) "Bodily injury" or "property damage" arising out of the sole negligence of the vendor for its own acts or omissions or those of its employees or anyone else acting on its behalf. However, this exclusion does not apply to:

- (1.1) The exceptions contained in Sub-paragraphs (iv) or (vi); or

- (1.2) Such inspections, adjustments, tests or servicing as the vendor has agreed to make or normally undertakes to make

in the usual course of business, in connection with the distribution or sale of the products.

- (b) This insurance does not apply to any insured person or organization, from whom you have acquired products, or any ingredient, part or container, entering into, accompanying or containing such products.

2. With respect to coverage provided by this Provision **A. Miscellaneous Additional Insureds**, the following additional provisions apply:

- a. Any insurance provided to an additional insured designated under Paragraphs **A.1.c.(1)** through **A.1.c.(8)** above does not apply:

- (1) To "bodily injury" or "property damage" included within the "products-completed operations hazard"; or

- (2) To "bodily injury", "property damage" or "personal and advertising injury" arising out of the sole negligence of such additional insured.

- b. The insurance afforded to such additional insured only applies to the extent permitted by law.

- c. The insurance afforded to such additional insured will not be broader than that which you are required to provide by the written contract or written agreement.

3. With respect to the insurance afforded to the additional insureds within this Provision **A. Miscellaneous Additional Insureds**, the following is added to **Section III – Limits Of Insurance**:

The most we will pay on behalf of the additional insured is the amount of insurance:

- a. Required by the written contract or written agreement; or

- b. Available under the applicable Limits Of Insurance shown in the Declarations;

whichever is less.

This endorsement shall not increase the applicable Limits Of Insurance shown in the Declarations.

**B. EXPECTED OR INTENDED INJURY OR DAMAGE**

Exclusion **2.a. Expected Or Intended Injury of Section I – Coverage A – Bodily Injury And Property Damage Liability** is deleted and replaced by the following:

**a. Expected Or Intended Injury Or Damage**

"Bodily injury" or "property damage" expected or intended from the standpoint of the insured. This exclusion does not apply to "bodily injury" or "property damage" resulting from the use of reasonable force to protect persons or property.

**C. KNOWLEDGE OF OCCURRENCE**

Paragraph **2.a. Duties In The Event Of Occurrence, Offense, Claim Or Suit of Section IV – Commercial General Liability Conditions** is deleted and replaced by the following:

- a. You must see to it that we are notified as soon as practicable of an "occurrence" or an offense which may result in a claim only when the "occurrence" or offense is known to:

- (1) You, if you are an individual;

- (2) A partner, if you are a partnership;

- (3) A manager, if you are a limited liability company; or

- (4) An "executive officer" or the "employee" designated by you to give such notice, if you are an organization other than a partnership or a limited liability company.

To the extent possible, notice should include:

- (i) How, when and where the "occurrence" or offense took place;

- (ii) The names and addresses of any injured persons and witnesses; and

- (iii) The nature and location of any injury or damage arising out of the "occurrence" or offense.

**D. LEGAL LIABILITY – DAMAGE TO PREMISES RENTED TO YOU (Fire, Lightning, Explosion, Smoke, Or Leakage From Automatic Fire Protective Systems)**

If damage to premises rented to you is not otherwise excluded from this policy or coverage part, then the following provisions apply:

- 1. Under **Section I – Coverage A – Bodily Injury And Property Damage Liability**, the last paragraph (after the exclusions) is deleted and replaced by the following:

Exclusions **c.** through **n.** do not apply to damage by fire, lightning, explosion, "smoke", or leakage from automatic fire protective systems to premises while rented to you or temporarily occupied by you with the permission of the owner. A separate limit of insurance applies to this coverage as described in **Section III – Limits Of Insurance.**

2. The paragraph immediately after Subparagraph **j.(6)** of Paragraph 2. **Exclusions of Section I – Coverage A – Bodily Injury And Property Damage Liability** is deleted and replaced by the following:

Paragraphs **(1), (3)** and **(4)** of this exclusion do not apply to "property damage" (other than damage by fire, lightning, explosion, "smoke", or leakage from automatic fire protective systems) to premises, including the contents of such premises, rented to you for a period of seven or fewer consecutive days. A separate limit of insurance applies to Damage To Premises Rented To You as described in **Section III – Limits Of Insurance.**

3. Paragraph **6.** of **Section III – Limits Of Insurance** is deleted and replaced by the following:

6. Subject to Paragraph **5.** above, the greater of:

- a. \$300,000; or
- b. The Damage To Premises Rented To You Limit shown in the Declarations,

is the most we will pay under **Coverage A** for damages because of "property damage" to premises while rented to you, or in the case of damage by fire, lightning, explosion, "smoke", or leakage from automatic fire protective systems, while rented to you or temporarily occupied by you with permission of the owner.

This limit will apply to all damage proximately caused by the same event, whether such damage results from fire, lightning, explosion, "smoke", leakage from automatic fire protective systems, or other covered causes of loss or any combination thereof.

4. Subparagraph **b.(1)(a)(ii)** of Paragraph 4. **Other Insurance of Section IV – Commercial General Liability Conditions** is deleted and replaced by the following:

- (ii) That is fire, lightning, explosion, "smoke" or leakage from automatic fire protective systems insurance for premises rented to

you or temporarily occupied by you with permission of the owner;

5. Subparagraph **a.** of Definition 9. "Insured contract" of **Section V – Definitions** is deleted and replaced by the following:

- a. A contract for a lease of premises. However, that portion of the contract for a lease of premises that indemnifies any person or organization for damage by fire, lightning, explosion, "smoke" or leakage from automatic fire protective systems to premises while rented to you or temporarily occupied by you with permission of the owner is not an "insured contract".

6. As used in this Provision **D. Legal Liability – Damage To Premises Rented To You:**

"Smoke" does not include smoke from agricultural smudging, industrial operations or "hostile fire".

#### **E. MEDICAL PAYMENTS**

The Medical Expense Limit is changed, subject to the terms of **Section III – Limits Of Insurance**, to the Medical Expense Limit shown in the Declarations.

#### **F. MOBILE EQUIPMENT REDEFINED**

Subparagraph **f.(1)** of Definition 12. "Mobile equipment" of **Section V – Definitions** is deleted and replaced by the following:

- (1) Equipment with a gross vehicle weight of 1,000 pounds or more and designed primarily for:

- (a) Snow removal;
- (b) Road maintenance, but not construction or resurfacing; or
- (c) Street cleaning;

#### **G. NEWLY FORMED OR ACQUIRED ORGANIZATION, PARTNERSHIP OR LIMITED LIABILITY COMPANY AND EXTENDED PERIOD OF COVERAGE**

Paragraph 3. of **Section II – Who Is An Insured** is deleted and replaced by the following:

3. Any organization you newly acquire or form, other than a joint venture, and over which you maintain ownership or:
  - a. Majority interest of more than 50% if you are a corporation;
  - b. Majority interest of more than 50% as a general partner of a newly acquired or formed partnership; and/or

- c. Majority interest of more than 50% as an owner of a newly acquired or formed limited liability company;

will qualify as a Named Insured if there is no other similar insurance available to that organization. However, for these organizations:

- (i) Coverage under this provision is afforded only until the next anniversary date of this policy's effective date after you acquire or form the organization, partnership or limited liability company, or the end of the policy period, whichever is earlier;
- (ii) **Section I – Coverage A – Bodily Injury And Property Damage Liability** does not apply to "bodily injury" or "property damage" that occurred before you acquired or formed the organization, partnership or limited liability company;
- (iii) **Section I – Coverage B – Personal And Advertising Injury Liability** does not apply to "personal and advertising injury" arising out of an offense committed before you acquired or formed the organization, partnership or limited liability company;
- (iv) Coverage applies only when operations of the newly acquired organization, partnership or limited liability company are the same or similar to the operations of insureds already covered under this insurance;
- (v) Coverage only applies for those limited liability companies who have established a date of formation as recorded within the filed state articles of organization, certificates of formation or certificates of organization; and
- (vi) Coverage only applies for those partnerships who have established a date of formation as recorded within a written partnership agreement or partnership certificate.

#### H. WHO IS AN INSURED – AMENDMENT

The last paragraph of **Section II – Who Is An Insured** is deleted and replaced by the following:

No person or organization is an insured with respect to the conduct of any:

- a. Current partnership or limited liability company, unless otherwise provided for under Paragraph 3. of **Section II – Who Is An Insured**;
- b. Current joint venture; or

- c. Past partnership, joint venture or limited liability company;

that is not shown as a Named Insured in the Declarations.

#### I. NON-OWNED WATERCRAFT

Subparagraph (2) of **Exclusion 2.g. Aircraft, Auto Or Watercraft of Section I – Coverage A – Bodily Injury And Property Damage Liability** is deleted and replaced by the following:

(2) A watercraft you do not own that is:

- (a) Less than 51 feet long; and
- (b) Not being used to carry persons or property for a charge.

#### J. SUPPLEMENTARY PAYMENTS – INCREASED LIMITS

**Section I – Supplementary Payments – Coverages A And B** is changed as follows:

1. The limit shown in Paragraph 1.b. for the cost of bail bonds is changed from \$250 to \$3,000; and
2. The limit shown in Paragraph 1.d. for loss of earnings because of time off from work is changed from \$250 a day to \$1,000 a day.

#### K. UNINTENTIONAL OMISSION OR UNINTENTIONAL ERROR IN DISCLOSURE

The following provision is added to Paragraph 6. **Representations of Section IV – Commercial General Liability Conditions**:

However, the unintentional omission of, or unintentional error in, any information given or provided by you shall not prejudice your rights under this insurance.

This provision does not affect our right to collect additional premium or to exercise our right of cancellation or non-renewal.

#### L. WAIVER OF TRANSFER OF RIGHTS OF RECOVERY AGAINST OTHERS

The following is added to Paragraph 8. **Transfer Of Rights Of Recovery Against Others To Us of Section IV – Commercial General Liability Conditions**:

We waive any right of recovery we may have against any person or organization because of payments we make for injury or damage arising out of your ongoing operations or "your work" and included in the "products-completed operations hazard" when you have agreed in a written contract or written agreement that any right of recovery is waived for such person or organization. This waiver applies only to the



person(s) or organization(s) agreed to in the written contract or written agreement and is subject to those provisions.

This waiver does not apply unless the written contract or written agreement has been executed prior to the "bodily injury" or "property damage".

However, if any person or organization is separately scheduled on a separate waiver of transfer of rights of recovery which is attached to this policy, then this waiver does not apply.

#### **M. LIBERALIZATION CLAUSE**

The following is added to **Section IV – Commercial General Liability Conditions**:

If we adopt a mandatory attachment form change which broadens coverage under this edition of the Commercial General Liability CG0001 for no additional charge, and those changes are intended to apply to all insureds under this edition of CG0001, that change will automatically apply to your insurance as of the date we implement the change in your state. This liberalization clause does not apply to changes implemented through introduction of a subsequent edition of the Commercial General Liability form CG0001.

#### **N. INCIDENTAL MEDICAL MALPRACTICE**

1. Paragraph 2.a.(1)(d) of **Section II – Who Is An Insured** does not apply to a physician, nurse practitioner, physician assistant, nurse, emergency medical technician or paramedic employed by you if you are not in the business or occupation of providing medical, paramedical, surgical, dental, x-ray or nursing services.
2. This provision is excess over any other valid and collectible insurance whether such insurance is primary, excess, contingent or on any other basis. Any payments by us will follow Paragraph 4.b. of **Section IV – Commercial General Liability Conditions**.

## WAIVER OF OUR RIGHT TO RECOVER FROM OTHERS ENDORSEMENT

We have the right to recover our payments from anyone liable for an injury covered by this policy. We will not enforce our right against the person or organization named in the Schedule. (This agreement applies **only** to the extent that you perform work under a written contract that requires you to obtain this agreement from us.)

This agreement shall not operate directly or indirectly to benefit anyone not named in the Schedule.

### Schedule

Any person or organization when you and such person or organization have agreed in a written, signed, or executed contract or agreement that such person or organization be added as walver of subrogation to your policy.

This endorsement changes the policy to which it is attached and is effective on the date issued unless otherwise stated.

**(The information below is required only when this endorsement is issued subsequent to preparation of the policy.)**

Endorsement Effective  
05/01/2023

Policy No.  
WCA 3275759

Endorsement No.

Insured

Premium

Pir Tano Construction Company LLC

Insurance Company:

Union Insurance Company

Countersigned by \_\_\_\_\_

# CUT SHEETS



# POLYMER CONCRETE BOX & COVER



TV304824PCT22

(SHOWN)

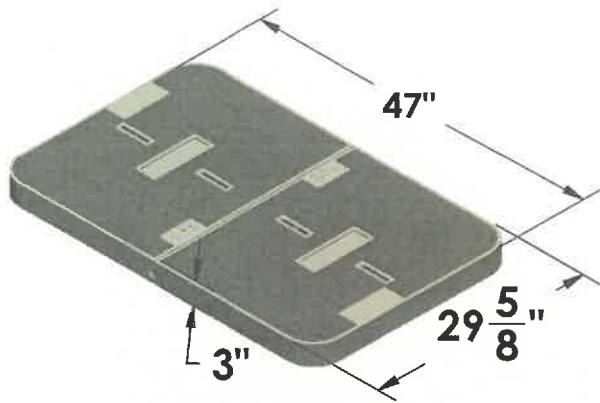

## COVER

Model 30" x 48" x 24"  
 Material Polymer Concrete  
 Style FLUSH SPLIT  
 Fasteners 1/2-13 SS Hex Bolt  
 Lift points 1/4" SS Rod

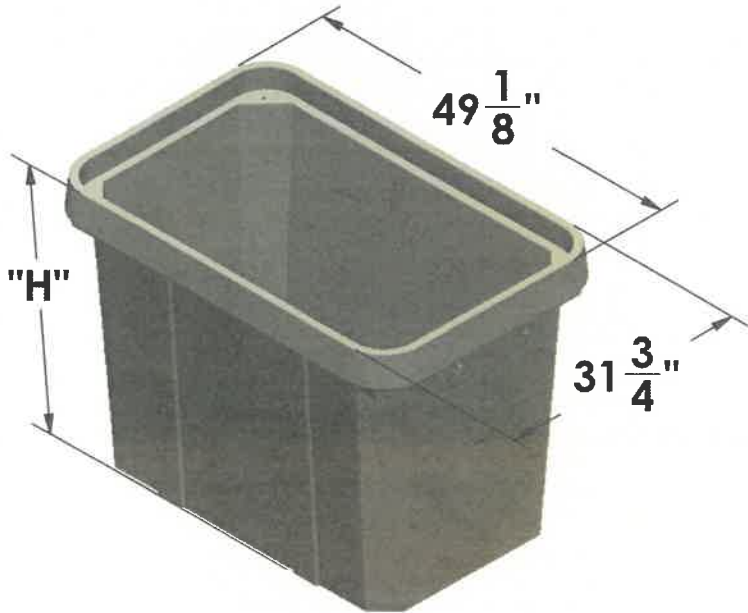

## Body

Model 30" x 48" x 24"  
 Material Polymer Concrete

## Notes

Rating Tier 22  
 Combined weight 580 lb.  
 Tolerance 1/8"  
 Weight may vary minimally

MODEL	WIDTH	LENGTH	HEIGHT*
TV132418PCT22	13"	24"	18"
TV173024PCT22	17"	30"	24"
TV243624PCT22	24"	36"	24"
TV243630PCT22	24"	36"	30"
TV243636PCT22	24"	36"	36"
TV304824PCT22	30"	48"	24"
TV304836PCT22	30"	48"	36"
TV484836PCT22	48"	48"	36"
TV366036PCT22	36"	60"	36"

\*DEPTH OPTIONS AVAILABLE ARE: 12", 18", 24", 30", 36", 48"

## Lateral Loading Requirements

Design Load: 800lbs/sq. ft  
 Test Load: 1200lbs/sq. ft

## Vertical Loading Requirements

Design Load: 22,500lbs  
 Test Load: 33,750lbs

**STANDARD**

# SMOOTHWALL



- Manufactured from flexible HDPE, makes gradual bends without special equipment
- Continuous lengths reduce joining costs
- Excellent low temperature properties, allows installation in cold climates
- Outstanding long term cable protection from shifting ground, rock and root impingement
- Provides a permanent pathway, simplifies future cable repairs or replacement

INSTALLATION TYPES	SIZE RANGE AVAILABLE			WALL TYPES	
Existing Conduit	0.5"	2.0"	6.0"	SDR-9	SCH-40
Plow	0.75"	2.5"	8.0"	SDR-11	SCH-80
Directional Bore	1.0"	3.0"	10.0"	SDR-13.5	SIDR-9
	1.25"	4.0"	12.0"	SDR-15.5	SIDR-11
	1.5"	5.0"		SDR-17	

**STANDARD COLORS**



FEATURES

<b>STANDARD</b>
<b>FOOTAGE MARKINGS</b> Sequential foot or meter markings. Custom print streams available.
<b>SPECIFICATIONS</b> All Smoothwall conduit dimensions meets or exceeds one or more of the following: ASTM F-2160, ASTM D-3035, ASTM D-2239, ASTM D-3485, NEMA TC-7, UL 651, UL 1990, Bellcore GR-356.
<b>OPTIONS</b>
<b>SILICORE</b> is co-extruded with the tough HDPE jacket creating a super, slick permanent lining. SILICORE lined ducts allow for higher speed cable jetting and longer cable pulls.
<b>PREINSTALLED TAPE</b> Factory pre-installed Bull-Line™ Pull Tape with EVEN-LOAD™, ensures extra slack at any access point throughout the reel. Available 500lb–6,000lb tensile strength or locatable.
<b>UL LISTING AVAILABLE</b> from ½"–6" for SDR 13.5, SCH 40 and SCH 80.
<b>EXTERNAL STRIPES</b> can be added from our standard color offering to facilitate visual identification.
<b>UV PROTECTANT</b> available for aerial/lashed placement.

SMOOTHWALL (SDR) TECHNICAL SPECIFICATIONS (SIZES 3"-12" NEXT PAGE)

PIPE SIZE	½"	¾"	1"	1¼"	1½"	2"	2 ½"	
WALL TYPE	NOM OD (IN)	0.840	1.050	1.315	1.660	1.900	2.375	2.875
	OD TOLERANCE +/-	0.004	0.005	0.007	0.008	0.010	0.012	0.014
	BEND RADIUS (IN) SUPPORTED	8	10	13	17	19	24	29
	BEND RADIUS (IN) UNSUPPORTED	16	20	26	34	38	48	58
SDR-9	MIN. WALL (IN)	0.093	0.117	0.146	0.184	0.211	0.264	0.319
	WALL TOLERANCE +	0.020	0.020	0.020	0.022	0.025	0.032	0.038
	AVG ID (IN)	0.634	0.796	1.003	1.270	1.453	1.815	2.199
	MIN ID (IN)	0.614	0.776	0.983	1.248	1.428	1.783	2.161
	WEIGHT (#/FT)	0.098	0.152	0.234	0.370	0.485	0.759	1.110
	SWPS (LBS)	525	821	1,288	1,052	2,688	4,200	6,155
SDR-11	MIN. WALL (IN)	0.076	0.095	0.120	0.151	0.173	0.216	0.261
	WALL TOLERANCE +	0.020	0.020	0.020	0.020	0.021	0.026	0.031
	AVG ID (IN)	0.668	0.840	1.055	1.338	1.533	1.917	2.322
	MIN ID (IN)	0.648	0.820	1.035	1.318	1.512	1.891	2.291
	WEIGHT (#/FT)	0.084	0.128	0.199	0.312	0.408	0.636	0.930
	SWPS (LBS)	440	687	1078	1717	2249	3515	5151
SDR-13.5	MIN. WALL (IN)	0.062	0.078	0.097	0.123	0.141	0.176	0.213
	WALL TOLERANCE +	0.020	0.020	0.020	0.020	0.020	0.021	0.026
	AVG ID (IN)	0.696	0.874	1.101	1.394	1.598	2.002	2.423
	MIN ID (IN)	0.676	0.854	1.081	1.374	1.578	1.981	2.397
	WEIGHT (#/FT)	0.072	0.110	0.167	0.263	0.342	0.528	0.775
	SWPS (LBS)	365	570	894	1425	1867	2917	4274
SDR-15.5	MIN. WALL (IN)	0.062	0.068	0.084	0.107	0.123	0.153	0.185
	WALL TOLERANCE +	0.018	0.020	0.020	0.020	0.020	0.020	0.022
	AVG ID (IN)	0.698	0.894	1.127	1.426	1.634	2.049	2.483
	MIN ID (IN)	0.680	0.874	1.107	1.406	1.614	2.029	2.461
	WEIGHT (#/FT)	0.071	0.098	0.149	0.234	0.304	0.467	0.680
	SWPS (LBS)			792	1,234	1,607	2,466	3,592
SDR-17	MIN. WALL (IN)		0.062	0.077	0.098	0.112	0.140	0.169
	WALL TOLERANCE +		0.020	0.020	0.020	0.020	0.020	0.020
	AVG ID (IN)		0.906	1.141	1.444	1.656	2.075	2.517
	MIN ID (IN)		0.886	1.121	1.424	1.636	2.055	2.497
	WEIGHT (#/FT)		0.091	0.138	0.217	0.281	0.432	0.625
	SWPS (LBS)		460	722	1150	1507	2355	3450

(SIZES 3"-12: NEXT PAGE)



Home / Fiber Optic Assemblies / Fiber Optic Pigtails /

6 Fiber LC/UPC Pigtail - 9/125µm Singlemode OS2 - Multi-Colored 900µm Jacket - 3 Meters in Total Length

## 6 Fiber LC/UPC Pigtail - 9/125µm Singlemode OS2 - Multi-Colored 900µm Jacket - 3 Meters in Total Length

6 Fiber LC/UPC Pigtail - 9/125µm Singlemode OS2 - Multi-Colored 900µm Jacket - 3 Meters in Total Length

Add to compare list

Item No: **SP-6LCSM3**

MFG Part#: **SP-6LCSM3**

Manufacturer: [Fibertronics, Inc.](#)

Please select the address you want to ship to ▾

We are online!



[MENU](#)[SEARCH](#)[Overview](#)[Specifications](#)[Contact Us](#)

This is a high-quality singlemode, OS2, 9/125 fiber optic pigtail with LC/UPC connectors. Fiber optic pigtails are ideal for fusion splicing. These pigtails provide the optical performance, sturdiness, and repeatability required for modern network applications by combining quality zirconia ferrules with tough composite hardware. They are quality tested to ensure they meet or exceed industry standards while adhering to only the most stringent performance specifications.

Fibertronics, Inc.'s simplex and duplex fiber pigtails are available with different fiber counts (commonly 1, 6 and 12) and come in various colors. Our fiber optic pigtails are available with LC, SC, FC, and ST connectors with a typical 0.9mm outer diameter cable. We also offer jacketed and unjacketed types.

Fibertronics, Inc. offers a variety of custom-made fiber optic pigtails with various connector types, please [contact us](#) to find out more.

## LC Fiber Optic Pigtail Features & Specifications



MENU

SEARCH

Operating Temperature: -40 ~ 75 °C

- Storage Temperature: -45~85°C
- Color-coded to easily identify in the field
- Low Insertion Loss
- Low Back Reflection Loss
- Ideal for use in Telecommunication Networks, LAN, WAN and Data Processing Networks
- Meets ISO9001, ROHS and Bell Core GR 326-core standards

## Applications of the Various Fiber Optic Connectors

### LC Connectors

These connectors are typically used in high-density applications due to their small size and their pull-proof design.

### SC Connectors

SC connectors are non-optical disconnect connectors with a 2.5mm pre-radiused zirconia ferrule. They are ideal for quick patching of cables into rack or wall mounts due to their push-pull design.

### FC Connectors

FC connectors feature a durable threaded coupling and are best suited for use within telecommunications applications and make use of non-optical disconnect.

### ST Connectors

ST connectors make use of a semi-unique bayonet connection with a 2.5mm ferrule. They are great fiber optic connectors for field installation because of their reliability and durability.

**Customers who bought this item also bought**

## FOSC™ Fiber Optic Tray Kit

### Product Classification

<b>Product Type</b>	Fiber splice tray
<b>Product Series</b>	FOSC 450
<b>Regional Availability</b>	North America
<b>Product Brand</b>	FOSC™

### General Specifications

<b>Application</b>	For use with FOSC-450 Fiber closures
<b>Package, quantity</b>	1

### Regulatory Compliance/Certifications

**Agency**  
RoHS 2011/65/EU

**Classification**  
Compliant



# HF-CCS PE30

**(HIGH-FLEX / OPEN-TRENCH)**

Tracer Wire • High-Flex Copper Clad Steel (HF-CCS) • 21% IACS Conductivity • Corrosion Resistant High-Density, High Molecular Weight Polyethylene (HMWPE-HDPE) Insulation • Moisture, Chemical, and Oil Resistant Impact, Crush, and Abrasion Resistant • RoHS Compliant • Direct Burial Rated • 30 Volts

**“PRO-TRACE® HF-CCS -- FLEXIBILITY & STRENGTH -- IT’S THE FUTURE OF TRACER WIRE”**



## Applications and Information

- **PRO-TRACE® HF-CCS PE30** is used for tracer wire applications not exceeding 30 Volts. Tracer wire is used to conductively locate buried utility lines for the gas, water, sewer, telecommunication, and electrical markets.
- **PRO-TRACE® HF-CCS PE30** is designed to embody the flexibility, memory, and feel of copper. It also has a 43% higher break-load, minimizing damage during installation and while in service. Equal to copper in signal tracing performance. It simply outperforms copper tracer wire. Designed for open-trench and plow-in installations using 1 wire.
- Considerably lower in cost and great price stability compared to copper.
- RoHS Compliant and works with connectors you already use.

## Standards and References

**PRO-TRACE® HF-CCS PE30** conductors meets or exceeds all applicable ASTM specifications, and requirements of the National Electrical Code.

- ASTM B910 / B190M: Standard Specification for Annealed Copper-Clad Steel Wire
- ASTM B170: Standard Specification for Oxygen-Free Electrolytic Copper
- ASTM D1248: Standard Specification for Polyethylene Plastics Extrusion Materials For Wire and Cable

## Construction

**PRO-TRACE® HF-CCS PE30** is a flexible, copper-clad steel tracer wire. A low carbon steel core, metallurgically bonded with a copper cladding, that is uniform and continuous, creating a bi-metal conductor that acts as one and is corrosion resistant. Special annealing processes are performed during the cladding process giving HF-CCS the flexibility and feel of copper, but 43% higher in strength which means less breaks than copper tracer wire.

**PRO-TRACE® HF-CCS PE30** uses a 30 mil, high-density, high molecular weight polyethylene (HDPE) insulation. HDPE provides an excellent balance of surface smoothness, processing ease and electrical consistency. HDPE provides superior strength against underground elements that help prevent accidental breaks caused by rocks in shifting soil conditions.

## Specification Example

Tracer wire for open-cut installation shall be a 12 AWG solid, PRO-TRACE® HF-CCS PE30. Conductor shall be annealed, 21% IACS, copper-clad steel, utilizing a AISI 1006 low carbon steel core with minimum break load of 282 lbs or 55,000 psi (required to meet break load, flexibility, and ASTM B910). Conductor shall be extruded with a 30 mil, high density, high molecular weight polyethylene (HMW-HDPE) pursuant to ASTM D1248. Tracer wire shall be rated for direct burial use at 30 volts and RoHS compliant. Tracer wire shall be PRO-TRACE® HF-CCS PE30 as manufactured by **Pro-Line Safety Products**.

Specification Updated: 1.4.2017 12:03:00 CST

**TABLE 1: CONDUCTOR (Physical, Mechanical and Electrical Properties)**

PROPERTY	18 AWG	16 AWG	14 AWG	12 AWG	10 AWG	8 AWG
Conductor Type	HF-CCS	HF-CCS	HF-CCS	HF-CCS	HF-CCS	HF-CCS
Conductor Temper	Annealed	Annealed	Annealed	Annealed	Annealed	Annealed
Steel Grade	AISI 1006	AISI 1006	AISI 1006	AISI 1006	AISI 1006	AISI 1006
Copper Grade	UNS C10200	UNS C10200	UNS C10200	UNS C10200	UNS C10200	UNS C10200
Rated Break Load (Minimum)	70 lbs	111 lbs	177 lbs	282 lbs	448 lbs	713 lbs
Rated Tensile Strength (Minimum)	55,000 psi	55,000 psi	55,000 psi	55,000 psi	55,000 psi	55,000 psi
Elongation (ASTM B869)	≥ 15.0%	≥ 15.0%	≥ 15.0%	≥ 15.0%	≥ 15.0%	≥ 15.0%
Nominal Copper Thickness (% of Diameter)	3.0%	3.0%	3.0%	3.0%	3.0%	3.0%
Nominal Copper Weight (Per 1,000')	13.0%	13.0%	13.0%	13.0%	13.0%	13.0%
Nominal DC Resistance	30,399 ohms	19,119 ohms	12,024 ohms	7,562 ohms	4,756 ohms	2,991 ohms

**TABLE 2: INSULATION & PRINTING (Physical, Mechanical and Electrical Properties)**

TEST DESCRIPTION	ASTM STANDARD	TYPICAL VALUES
Density @ 23°C	ASTM D1505	0.945 g/cm <sup>3</sup>
Melt Flow Rate	ASTM D1238	0.70 g/10 min
Tensile Strength	ASTM D638	3,400 psi
Tensile Strength Retention	ASTM D638	90% after 48 hours @ 100°C
Tensile Elongation	ASTM D638	500%
Tensile Elongation Retention	ASTM D638	90% after 48 hours @ 100°C
Environmental Stress Cracking	ASTM D1693	0 failures @ 48 hours
Thermal Stress Cracking	ASTM D2951	0 failures @ 96 hours
Brittleness Temperature	ASTM D746	-76°C
Melting Temperature	ASTM D3418	260°C
Oxidative Induction Time	ASTM D3895	170 min @ 200°C
Dielectric Constant	ASTM D1531	2.32 @ 1 MHz
Dissipation Factor	ASTM D1531	0.00006 @ 1 MHz
DC Volume Resistivity @ 23°C	ASTM D257	> 1 x 10 <sup>15</sup> ohm-cm

**TABLE 3: ORDERING INFORMATION (Weights, Measurements, and Packaging)**

PRODUCT PART NO.	PRODUCT DESCRIPTION	RATED BREAK LOAD	RATED TENSILE STRENGTH	HDPE INSULATION THICKNESS	NOMINAL O.D.	APPROX. WEIGHT PER 1,000 FT		STANDARD PACKAGES
						CCS WEIGHT	FINISHED WEIGHT	
<b>PRO-TRACE HF-CCS PE30 TRACER WIRE -- OPEN-CUT, PLOW-IN, BLOW-IN</b>								
74418.XXXX	18 AWG HF-CCS PE30	70 lbs	55,000 psi	0.030"	0.101"	4.4191	7.14	500' / 1000' / 2500'
74416.XXXX	16 AWG HF-CCS PE30	112 lbs	55,000 psi	0.030"	0.111"	7.0219	10.15	500' / 1000' / 2500'
74411.XXXX	14 AWG HF-CCS PE30	177 lbs	55,000 psi	0.030"	0.124"	11.1800	14.82	500' / 1000' / 2500'
74412.XXXX	12 AWG HF-CCS PE30	282 lbs	55,000 psi	0.030"	0.141"	17.7644	22.05	500' / 1000' / 2500'
74413.XXXX	10 AWG HF-CCS PE30	448 lbs	55,000 psi	0.030"	0.162"	28.2537	33.35	500' / 1000' / 2500'
74414.XXXX	8 AWG HF-CCS PE30	713 lbs	55,000 psi	0.030"	0.189"	44.9297	51.05	CUSTOM ORDER

PRO-TRACE® • 12 AWG SOLID HF-CCS • 30 MIL HDPE • HIGH-FLEX TRACER WIRE (282 LBS) • 30V • DIRECT BURIAL • CAUTION GAS LINE BELOW

INSULATION COLOR AND REEL SIZE			
COLOR	500' REEL	1000' REEL	2500' REEL
BLACK	0132	0141	0147
BLUE	0232	0241	0247
BROWN	0332	0341	0347
GREEN	0532	0541	0547
ORANGE	0632	0641	0647
PURPLE	0832	0841	0847
RED	0932	0941	0947
WHITE	1132	1141	1147
YELLOW	1232	1241	1247

\*\*\* Some colors and sizes may be subject to mins \*\*\*

REEL AND PACKAGING INFORMATION					
SIZE	LENGTH	MATERIAL	REEL DIMENSION	ARBOR HOLE	PALLET QUANTITY
14 AWG	500	PLYWOOD or PLASTIC	8" x 4"	1.5"	162,000 FT
	1000	PLYWOOD or PLASTIC	8" x 9"	1.5"	180,000 FT
	2500	PLYWOOD or PLASTIC	12" x 6"	1.5"	180,000 FT
12 AWG	500	PLYWOOD or PLASTIC	8" x 4"	1.5"	126,000 FT
	1000	PLYWOOD or PLASTIC	8" x 9"	1.5"	108,000 FT
	2500	PLYWOOD or PLASTIC	12" x 9"	1.5"	120,000 FT
10 AWG	500	PLYWOOD or PLASTIC	8" x 6"	1.5"	72,000 FT
	1000	PLYWOOD or PLASTIC	12" x 6"	1.5"	80,000 FT
	2500	PLYWOOD or PLASTIC	12" x 12"	1.5"	80,000 FT

\*\*\* Custom length reels are available upon request, some restrictions may apply \*\*\*  
 \*\*\* Bulk reels up to 60,000' are available, some restrictions may apply \*\*\*



### LightScope ZWP® Single Jacket/Single Armor, Gel-Free, Outdoor Stranded Loose Tube Cable

- Corrugated steel tape armor is strong yet flexible, providing additional crush and rodent protection

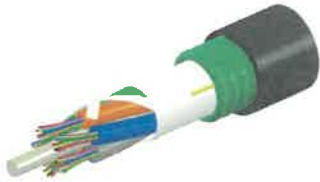

### Product Classification

<b>Portfolio</b>	CommScope®
<b>Product Type</b>	Fiber OSP cable
<b>Regional Availability</b>	Asia   Australia/New Zealand   EMEA   Latin America   North America

### Standards And Qualifications

<b>Cable Qualification Standards</b>	ANSI/CEA S-87-640   EN 187105   Telcordia GR-20
--------------------------------------	---

### Representative Image

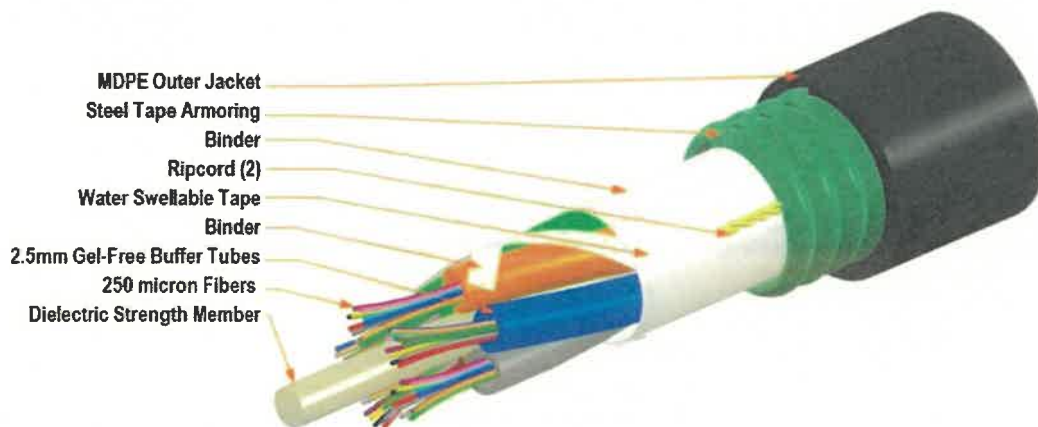

### General Specifications

<b>Cable Type</b>	Stranded loose tube
<b>Construction Type</b>	Armored
<b>Subunit Type</b>	Gel-free

### Construction Materials

<b>Fiber Type Solution</b>	G.652.D and G.657.A1
<b>Jacket Material</b>	PE
<b>Total Fiber Count</b>	12

<b>Armor Type</b>	Corrugated steel
<b>Fiber Type</b>	G.652.D and G.657.A1
<b>Fiber Type, quantity</b>	12
<b>Fibers per Subunit, quantity</b>	12
<b>Jacket Color</b>	Black
<b>Jacket UV Resistance</b>	UV stabilized

## Dimensions

<b>Buffer Tube/Subunit Diameter</b>	2.50 mm   0.10 in
<b>Cable Weight</b>	110.0 kg/km   74.0 lb/kft
<b>Diameter Over Jacket</b>	11.50 mm   0.45 in
<b>Filler, quantity</b>	4
<b>Subunit, quantity</b>	1

## Physical Specifications

<b>Minimum Bend Radius, loaded</b>	17.3 cm   6.8 in
<b>Minimum Bend Radius, unloaded</b>	11.5 cm   4.5 in
<b>Tensile Load, long term, maximum</b>	800 N   180 lbf
<b>Tensile Load, short term, maximum</b>	2700 N   607 lbf
<b>Vertical Rise, maximum</b>	740.0 m   2429.0 ft

## Environmental Specifications

<b>Environmental Space</b>	Aerial, lashed   Buried
<b>Installation Temperature</b>	-30 °C to +70 °C (-22 °F to +158 °F)
<b>Operating Temperature</b>	-40 °C to +70 °C (-40 °F to +158 °F)
<b>Storage Temperature</b>	-40 °C to +75 °C (-40 °F to +167 °F)

## Mechanical Test Specifications

<b>Compression</b>	44 N/mm   250 lb/in
<b>Compression Test Method</b>	FOTP-41   IEC 60794-1 E3
<b>Flex</b>	35 cycles
<b>Flex Test Method</b>	FOTP-104   IEC 60794-1 E6
<b>Impact</b>	4.41 N-m   3.25 ft lb
<b>Impact Test Method</b>	FOTP-25   IEC 60794-1 E4
<b>Strain</b>	See long and short term tensile loads
<b>Strain Test Method</b>	FOTP-33   IEC 60794-1 E1
<b>Twist</b>	10 cycles
<b>Twist Test Method</b>	FOTP-85   IEC 60794-1 E7

**Water Penetration** 24 h  
**Water Penetration Test Method** FOTP-82 | IEC 60794-1 F5

## Environmental Test Specifications

**Cable Freeze** -2 °C | 28 °F  
**Cable Freeze Test Method** FOTP-98 | IEC 60794-1 F15  
**Heat Age** -40 °C to +85 °C (-40 °F to +185 °F)  
**Heat Age Test Method** IEC 60794-1 F9  
**Low High Bend** -30 °C to +60 °C (-22 °F to +140 °F)  
**Low High Bend Test Method** FOTP-37 | IEC 60794-1 E11  
**Temperature Cycle** -40 °C to +70 °C (-40 °F to +158 °F)  
**Temperature Cycle Test Method** FOTP-3 | IEC 60794-1 F1

## Regulatory Compliance/Certifications

Agency	Classification
RoHS 2011/65/EU	Compliant
ISO 9001:2015	Designed, manufactured and/or distributed under this quality management system



## Included Products

DB-8W-LT (Product Component—not orderable) — LightScope ZWP® Singlemode Fiber

### \* Footnotes

**Operating Temperature** Specification applicable to non-terminated bulk fiber cable

## LightScope ZWP® Single Jacket/Single Armor, Gel-Free, Outdoor Stranded Loose Tube Cable

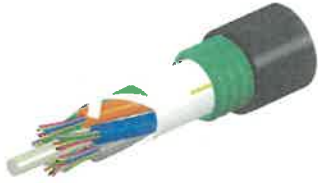

- Corrugated steel tape armor is strong yet flexible, providing additional crush and rodent protection

### Product Classification

<b>Portfolio</b>	CommScope®
<b>Product Type</b>	Fiber OSP cable
<b>Regional Availability</b>	Asia   Australia/New Zealand   EMEA   Latin America   North America

### Standards And Qualifications

<b>Cable Qualification Standards</b>	ANSI/ICEA S-87-640   EN 187105   Telcordia GR-20
--------------------------------------	--

### Representative Image

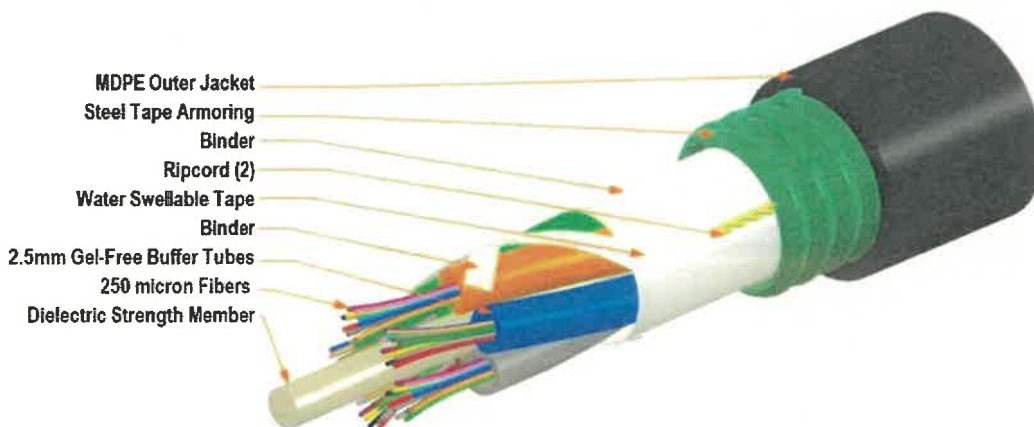

### General Specifications

<b>Cable Type</b>	Stranded loose tube
<b>Construction Type</b>	Armored
<b>Subunit Type</b>	Gel-free

### Construction Materials

<b>Fiber Type Solution</b>	G.652.D and G.657.A1
<b>Jacket Material</b>	PE
<b>Total Fiber Count</b>	24



<b>Armor Type</b>	Corrugated steel
<b>Fiber Type</b>	G.652.D and G.657.A1
<b>Fiber Type, quantity</b>	24
<b>Fibers per Subunit, quantity</b>	12
<b>Jacket Color</b>	Black
<b>Jacket UV Resistance</b>	UV stabilized

## Dimensions

<b>Buffer Tube/Subunit Diameter</b>	2.50 mm   0.10 in
<b>Cable Weight</b>	110.0 kg/km   74.0 lb/kft
<b>Diameter Over Jacket</b>	11.50 mm   0.45 in
<b>Filler, quantity</b>	3
<b>Subunit, quantity</b>	2

## Physical Specifications

<b>Minimum Bend Radius, loaded</b>	17.3 cm   6.8 in
<b>Minimum Bend Radius, unloaded</b>	11.5 cm   4.5 in
<b>Tensile Load, long term, maximum</b>	800 N   180 lbf
<b>Tensile Load, short term, maximum</b>	2700 N   607 lbf
<b>Vertical Rise, maximum</b>	740.0 m   2429.0 ft

## Environmental Specifications

<b>Environmental Space</b>	Aerial, lashed   Buried
<b>Installation Temperature</b>	-30 °C to +70 °C (-22 °F to +158 °F)
<b>Operating Temperature</b>	-40 °C to +70 °C (-40 °F to +158 °F)
<b>Storage Temperature</b>	-40 °C to +75 °C (-40 °F to +167 °F)

## Mechanical Test Specifications

<b>Compression</b>	44 N/mm   250 lb/in
<b>Compression Test Method</b>	FOTP-41   IEC 60794-1 E3
<b>Flex</b>	35 cycles
<b>Flex Test Method</b>	FOTP-104   IEC 60794-1 E6
<b>Impact</b>	4.41 N-m   3.25 ft lb
<b>Impact Test Method</b>	FOTP-25   IEC 60794-1 E4
<b>Strain</b>	See long and short term tensile loads
<b>Strain Test Method</b>	FOTP-33   IEC 60794-1 E1
<b>Twist</b>	10 cycles
<b>Twist Test Method</b>	FOTP-85   IEC 60794-1 E7

**Water Penetration** 24 h  
**Water Penetration Test Method** FOTP-82 | IEC 60794-1 F5

## Environmental Test Specifications

**Cable Freeze** -2 °C | 28 °F  
**Cable Freeze Test Method** FOTP-98 | IEC 60794-1 F15  
**Heat Age** -40 °C to +85 °C (-40 °F to +185 °F)  
**Heat Age Test Method** IEC 60794-1 F9  
**Low High Bend** -30 °C to +60 °C (-22 °F to +140 °F)  
**Low High Bend Test Method** FOTP-37 | IEC 60794-1 E11  
**Temperature Cycle** -40 °C to +70 °C (-40 °F to +158 °F)  
**Temperature Cycle Test Method** FOTP-3 | IEC 60794-1 F1

## Regulatory Compliance/Certifications

Agency	Classification
RoHS 2011/65/EU	Compliant
ISO 9001:2015	Designed, manufactured and/or distributed under this quality management system



## Included Products

DB-8W-LT (Product Component—not orderable) — LightScope ZWP® Singlemode Fiber

## \* Footnotes

**Operating Temperature** Specification applicable to non-terminated bulk fiber cable

# Closet Connector Housing (CCH) One rack unit, holds two CCH connector panels



**Part Number:**  
**CCH-01U**

Closet connector housings (CCHs) provide interconnect or cross-connect capabilities between outside plant, riser or distribution cables and opto-electronics. Like other LANscape solutions hardware, the housings accept CCH connector panels. In addition, the housings accept CCH cassettes and CCH modules.

From fiber and cable routing and strain relief, to port labeling and termination, these housings reduce the risk of error that can disrupt networks. The units are designed for rack mounting in 19 (48 cm) racks or optional 23 (58 cm) equipment racks (1.75 EIA hole spacing). They are available in rack space options of 1 U (two panels, cassettes or modules), 2 U (four panels, cassettes or modules), 3 U (six panels, cassettes or modules) and 4 U (12 panels, cassettes or modules). The 1 U, 2 U and 3 U options feature a slide-out tray and see-through, removable top covers. The CCH-04U features a clear door, removable front and rear enclosures and a platinum-colored interior for maximum visibility and access.

Every CCH housing is shipped complete with strain relief brackets, routing clips and guides, and mounting brackets for proper installation. Documentation labels are provided and components can be added as needed to construct a fiber distribution frame for any application. All housings include a removable tinted polycarbonate front door.

## Features and Benefits

**Durable, polycarbonate-tinted front door for viewing jumpers**

Ideal for pigtail splicing

**Removable, translucent top covers (1U, 2U, 3U), removable rear cover (4U)**

Visibility and ease of access for installation, testing, and troubleshooting

**Internal and external strain-relief options**

Flexibility for installation and moves, adds, and changes (MACs)

**Accepts panels, modules, and cassettes**

Variety of field-termination options

**Adaptable to use as a modular splice housing**

Splices are stored and protected in same footprint



# Closet Connector Housing (CCH) One rack unit, holds two CCH connector panels



## Specifications

General Specifications	
Product Type	Fiber Optic Hardware
Environment	Indoor
Access Type	Front and rear access slidable
Lockable	Yes
Mounting Type	Rack 19-in, Rack 23-in, Cabinet-mount
Application	Carrier Networks, Data Center, Enterprise Networks

Standards	
RoHS	Free of hazardous substances according to RoHS 2011/65/EU
Approvals and Listings	Meets ANSI/TIA/EIA-568A and 606, Tested in accordance with Telecordia GR-63-CORE, UL1863 - Communication Circuit Accessories
UL-Listed	United States and Canadian safety standards

Environmental Conditions	
Temperature Range, Operation	-40 °C to 70 °C (-40 °F to 158 °F )

Design	
Fiber Count	48
Housing Material	Powder-coated metal and polycarbonate tray
Number of Modules	2
Cable entry type	External and Internal strain-relief bracket
Number of Panels/Cassettes per Housing	2
Pigtail Length	2.25 m (7.38 ft)
Housing Type	CCH
Locking Availability	Front or rear

# Closet Connector Housing (CCH) One rack unit, holds two CCH connector panels

CORNING

## Design

Panel or Cassette Type	CCH
Panel or Module Type	CCH
Splice Tray Options	CCH Pigtailed Splice Cassette (CCH-CS)
Number of Ports	24

## Dimensions

Height	44 mm (1.73 in)
Depth	430 mm (16.93 in)
Weight	3.9 kg

## Ordering Information

Product Number	CCH-01U
EAN Code	4056418169491
Package Contents	"Closet Connector Housing 1U, 2 blank panels, Installation kit with mounting screws, Internal and external strain relief brackets, Label Cards"
Shipping Weight	4.5 kg
Height Unit	1 U
Units per Delivery	1/1
Shipping Height	5461 cm
Shipping Width	57.15 mm (2.25 in)
Shipping Depth	1905 cm



Corning Optical Communications LLC • 4200 Corning Place • Charlotte, NC • 28216 • United States  
800-743-2675 • FAX: 828-325-5060 • International: +1-828-901-5000 • [www.corning.com/opcomm](http://www.corning.com/opcomm)

A complete listing of the trademarks of Corning Optical Communications is available at [www.corning.com/opcomm/trademarks](http://www.corning.com/opcomm/trademarks). All other trademarks are the properties of their respective owners. Corning Optical Communications is ISO 9001 certified. © 2024 Corning Optical Communications. All rights reserved.

# Closet Connector Housing Panels (CCH-CP)

CORNING

## Features and Benefits

### Universal design approach

One-size-fits-all LANscape® Solutions housings

### Broadest range of fiber count and adapter types

Solutions for all needs

### Colored icon labeling

Easy connector identification

Corning closet connector housing panels (CCH-CP) are offered in a variety of fiber counts for use with LANscape® solutions hardware products for a “one-size-fits-all” approach. Used with factory-installed or field-installable connectors, these panels provide inter-connect or cross-connect capability in a housing at main cross-connects, intermediate cross-connects, telecommunication rooms or work areas. Available with a variety of industry-standard adapter types, the CCH-CP provides an efficient way to securely mate two connectors and offers multimode and single-mode applications in 6-, 8-, 12-, 16- and 24-fiber count options, plus 36-, 72-, 96- and 144-fiber count options with MTP® connector adapters.

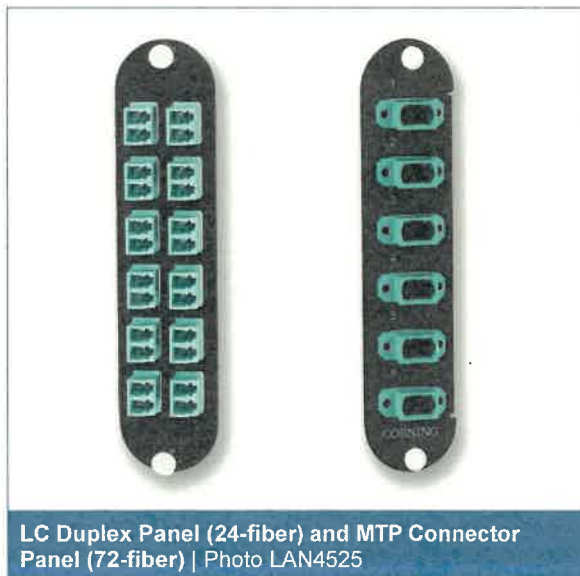

LC Duplex Panel (24-fiber) and MTP Connector Panel (72-fiber) | Photo LAN4525



ST Compatible Panel (12-fiber) and SC Duplex Connector Panel (12-fiber) | Photo LAN4526



# Closet Connector Housing Panels (CCH-CP)



## Ordering Information

CCH-CP   -

1
2

**1** Select fiber count.

- 06 = 6 fibers
  - 08 = 8 fibers
  - 12 = 12 fibers
  - 16 = 16 fibers
  - 24 = 24 fibers
  - 36 = 36 fibers
  - 72 = 72 fibers
  - 96 = 96 fibers
  - E4 = 144 fibers
- See Note 1.*

**2** Select adapter code (see Adapter/Connector Code Options table).

Note: Fiber count for desired adapter is available in table on following page.

## Part Number Example

Part Number	Product Description	Units per Delivery	
CCH-CP12-A9	Closet Connector Housing (CCH) Panel, LC adapters, Duplex, UPC, 12 F, Single-mode (OS2)	1/1	

# Closet Connector Housing Panels (CCH-CP)

CORNING

Adapter Code	Fiber Type	Alignment	Housing	Fiber/Adapter	Available Fiber/Panel Counts								
					6	8	12	16	24	36	72	96	144
<b>LC Duplex</b>													
A8	62.5 μm multimode (OM1)	Ceramic	Composite	2	X	X	X	X	X				
D3	50 μm multimode (OM2)	Ceramic	Composite	2	X	X	X	X	X				
E4	50 μm multimode (OM3/4)	Ceramic	Composite	2	X	X	X	X	X				
A9	Single-mode, UPC (OS2)	Ceramic	Composite	2	X	X	X	X	X				
B3	Single-mode, APC (OS2)	Ceramic	Composite	2	X	X	X	X	X				
<b>LC Duplex Shuttered</b>													
AB	62.5 μm multimode (OM1)	Ceramic	Composite	2	X	X	X	X	X				
AC	50 μm multimode (OM2)	Ceramic	Composite	2	X	X	X	X	X				
AD	50 μm multimode (OM3/4)	Ceramic	Composite	2	X	X	X	X	X				
AE	Single-mode, UPC (OS2)	Ceramic	Composite	2	X	X	X	X	X		X		
AF	Single-mode, APC (OS2)	Ceramic	Composite	2	X	X	X	X	X				
<b>Non-keyed LC Duplex</b>													
BE	Single-mode, red, UPC (OS2)	Ceramic	Composite	2	X	X	X	X	X				
BF	Single-mode, black, UPC (OS2)	Ceramic	Composite	2	X	X	X	X	X				
BG	Single-mode, yellow, UPC (OS2)	Ceramic	Composite	2	X	X	X	X	X				
BH	Single-mode, green, UPC (OS2)	Ceramic	Composite	2	X	X	X	X	X				
BJ	Single-mode, violet, UPC (OS2)	Ceramic	Composite	2	X	X	X	X	X				
BK	Single-mode, orange, UPC (OS2)	Ceramic	Composite	2	X	X	X	X	X				
BL	Single-mode, rose, UPC (OS2)	Ceramic	Composite	2	X	X	X	X	X				
BM	Single-mode, slate, UPC (OS2)	Ceramic	Composite	2	X	X	X	X	X				
<b>SC Duplex</b>													
91	62.5 μm multimode (OM1)	Metal	Composite	2	X	X	X						
G7	50 μm multimode (OM2)	Ceramic	Composite	2	X	X	X						
E7	50 μm multimode (OM3/4)	Ceramic	Composite	2	X	X	X						
59	Single-mode, UPC (OS2)	Ceramic	Composite	2	X	X	X						
D9	Single-mode, APC (OS2)	Ceramic	Composite	2	X	X	X						
<b>SC</b>													
56	62.5 μm multimode (OM1)	Metal	Composite	1	X	X	X						
G6	50 μm multimode (OM2)	Ceramic	Composite	1	X	X	X						
E6	50 μm multimode (OM3/4)	Ceramic	Composite	1	X	X	X						
3C	Single-mode, UPC (OS2)	Ceramic	Composite	1	X	X	X						
6C	Single-mode, APC (OS2)	Ceramic	Composite	1	X	X	X						
<b>ST® Compatible Connector</b>													
15T	62.5 μm multimode (OM1)	Ceramic	Metal	1	X	X	X						
G5	50 μm multimode (OM2)	Ceramic	Metal	1	X	X	X						
H3	50 μm multimode (OM3/4)	Ceramic	Metal	1	X	X	X						
19T	Single-mode, UPC (OS2)	Ceramic	Metal	1	X	X	X						
<b>FC</b>													
11	Single-mode, UPC (OS2)	Metal	Metal	1	X	X	X						
21	Single-mode, APC (OS2)	Metal	Metal	1	X	X	X						
<b>MTP® Connector</b>													
69	62.5 μm multimode (OM1)	N/A	Composite	12						X	X	X	X
G3	50 μm multimode (OM2)	N/A	Composite	12						X	X	X	X
E3	50 μm multimode (OM3/4)	N/A	Composite	12						X	X	X	X
90	Single-mode (OS2)	N/A	Composite	12						X	X	X	X

Fiber Type

Housing Color, Simplex and Duplex

Housing Color, MTP

62.5 μm multimode (OM1)  
 50 μm multimode (OM2)  
 50 μm multimode (OM3/4)  
 Single-mode, UPC (OS2)  
 Single-mode, APC (OS2)

Beige  
 Black  
 Aqua  
 Blue  
 Green

Black  
 Black  
 Aqua  
 Black  
 Black



# Closet Connector Housing Panels (CCH-CP)



CORNING

## Notes



**Corning Optical Communications LLC • PO Box 489 • Hickory, NC 28603-0489 USA**  
**800-743-2675 • FAX: 828-325-5060 • International: +1-828-901-5000 • [www.corning.com/opcomm](http://www.corning.com/opcomm)**

A complete listing of the trademarks of Corning Optical Communications is available at [www.corning.com/opcomm/trademarks](http://www.corning.com/opcomm/trademarks).  
All other trademarks are the properties of their respective owners. Corning Optical Communications is ISO 9001 certified.

© 2016 Corning Optical Communications. All rights reserved.



FOSC® 450 B6 Fiber Optic Splice Closure, Gel Cable sealing, no pre-installed tray, 6 cable attach., three ground feedthrough lugs, with test valve

- Single-ended, O-ring sealed dome closure for splicing feeder and distribution cables
- Gel cable sealing technology allows easy adding or removing of a wide size range of cables
- Compatible with most common cable types: e.g. loose tube, central core, ribbon fiber
- FOSC splice trays hinged for access to any splice without disturbing other trays
- Closure can be used in aerial, pedestal and underground (up to 5 meters) environments
- Compatible with CommScope's CWDM modules and optical splitter trays

## Product Classification

<b>Regional Availability</b>	Latin America   North America
<b>Product Type</b>	Single-ended, round fiber closure
<b>Product Brand</b>	FOSC®
<b>Product Series</b>	FOSC 450

## General Specifications

<b>Cable Entry Drop Port Style</b>	Round
<b>Cable Entry Main Port Style</b>	Round
<b>Cable Ports Quantity, total</b>	6 round ports
<b>Cable Sealing Type</b>	Compressed gel
<b>Closure Sealing Type</b>	Dome-to-base clamp with O-ring
<b>Closure Style</b>	Single-ended
<b>Color</b>	Black
<b>Fiber Storage Basket Type</b>	B6, BS standard size
<b>Flash Test Valve</b>	Pre-installed
<b>Ground Feed-through</b>	Included
<b>Mounting</b>	Pole   Strand   Wall
<b>Network Area Type</b>	Feeder
<b>Splice Tray Included, quantity</b>	0
<b>Splice Tray Type Included</b>	No trays
<b>Splicing Capacity, Mass Fusion, maximum</b>	288
<b>Splicing Capacity, Single Fusion, maximum</b>	144

# 058514-000 | FOSC450-B6-6-NT-0-B3V

<b>Splicing Capacity, Single Splice, 12 fibers, maximum</b>	144
<b>Splicing Capacity, Single Splice, 6 fibers, maximum</b>	72
<b>Splicing Type, Supported</b>	Mass fusion   Single fusion

## Dimensions

<b>Length</b>	610 mm   24.016 in
<b>Diameter</b>	249 mm   9.803 in
<b>Diameter, with clamp</b>	291 mm   11.457 in
<b>Main Cable Diameter, maximum</b>	25 mm   0.984 in

## Dimension Drawing

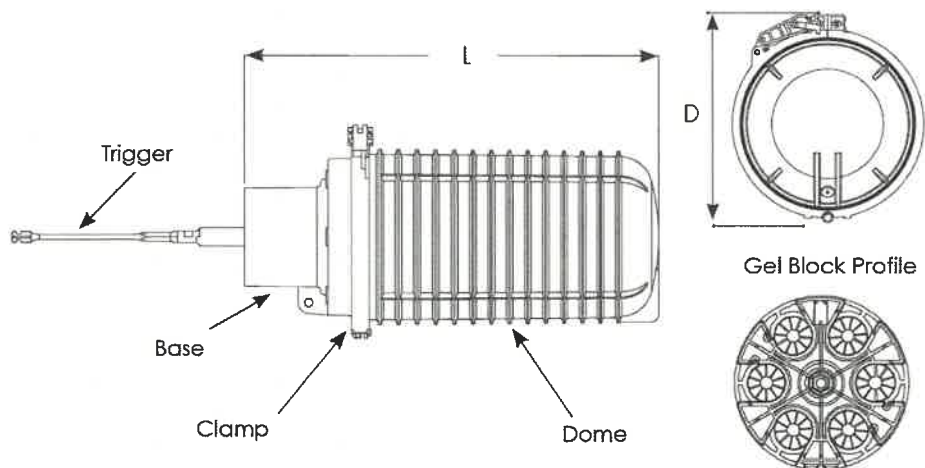

## Ordering Tree

# 058514-000 | FOSC450-B6-6-NT-0-B3V

## FOSC 450 - XX - X - XX - X - X X X

### Closure Size (inches)

A4	4 cable entry ports; 8 dia. x 19 long
B6	6 cable entry ports; 9 dia. x 19.5 long
B6	6 cable entry ports; 10 dia. x 24 long
C6	6 cable entry ports; 11.5 dia. x 23 long
D6	6 cable entry ports; 11.5 dia. x 30 long

### Termination Hardware Quantity for the Kit

2	2 cable attachments included
4	4 cable attachments included
6	6 cable attachments included (N/A for A size)

### Capacity and Type of Splice Tray

0	No tray installed in factory
1	A, B, or C tray with two SM6 splice modules
2	A, B, or C tray with two SM12 splice modules
3	D tray with six SM6 splice modules
4	D tray with six SM12 splice modules
5	A, B size ribbon tray (accommodates 12 ribbons/144 fibers)
6	D size ribbon tray (24 ribbons/288 fibers)
7	C size ribbon tray (18 ribbons/216 fibers)
8	Stackable single fusion trays (12 splices)

\*Note: SMOLBY (12001) splice protection sleeves are highly recommended for use with SM12 splice modules

### Quantity of Splice Trays Factory Installed

0	Choose either "0" trays (no trays installed) or "1" tray installed. Additional trays sold separately.
---	---

### Valve for Flash Testing

V	Valve (standard)
N	No Valve

Note: We recommend flash test valves for FOSC closures. However, nonvalved closures are available upon request

### Number of Ground Feed-through Lugs

0	No grounding
1	1 ground feed-through lug (A4 only, N/A for B6)
2	3 ground feed-through lugs (B6, C6, and D6 closures only, N/A for BS)
6	6 ground feed-through lugs (C6 and D6 closure only, N/A for BS)

Note: FEG and MEG kits provide optional ground isolation for FOSC 450 closures.

### Slack Basket Type

N	No Basket
A	A4 Standard Size
B	B6, BS Standard Size
C	C6 Standard Size
D	D6 Standard Size
E	Special Bulkhead Basket arrangement for B, BS closures only
T	Tail Size
S	Stackable Trays in D Closure

Note: D-size closures with "N" option include backbone used to route ribbons to ribbon trays. A and B-size closures include storage "socks".

## Material Specifications

### Material Type

Impact-resistant polymer

## Environmental Specifications

### Environmental Space

Below ground | Buried

### Qualification Standards

IEC 61300, 5 m waterhead

### Water Resistance

Flash test valve at 5 psi (40 kPa)

## Packaging and Weights

### Packaging quantity

1

### Packaging Type

Box | Carton

### Weight, net

5.9 kg | 13.007 lb

## Regulatory Compliance/Certifications

**Agency****Classification**

CHINA-ROHS

Below maximum concentration value

ISO 9001:2015

Designed, manufactured and/or distributed under this quality management system

REACH-SVHC

Compliant as per SVHC revision on [www.commscope.com/ProductCompliance](http://www.commscope.com/ProductCompliance)

ROHS

Compliant

UK-ROHS

Compliant





## SMOUV Fiber Optic Splice Heat Shrink Protective Sleeve, pack of 100 pcs

- Provide mechanical and environmental protection for fusion splices
- Optimal design for simple and correct fiber entrance
- Hot melt adhesive especially developed for optimal flow
- Transparent heat shrinkable tube for simple installation verification
- Short installation cycle and compatible with most common ovens

### Product Classification

<b>Regional Availability</b>	Asia   Australia/New Zealand   EMEA   Latin America   North America
<b>Product Type</b>	Fiber protection sleeve
<b>Product Brand</b>	SMOUV®
<b>Product Series</b>	SMOUV
<b>Ordering Note</b>	Minimum order quantity (MOQ) is 1,000 pcs

### General Specifications

<b>Application</b>	single fusion splices
<b>Splicing Type</b>	Heat shrink, single fiber fusion

### Dimensions

<b>Length</b>	61 mm   2.402 in
---------------	------------------

### Outline Drawing



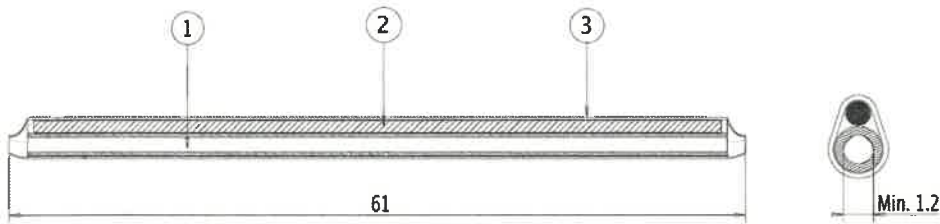

- 1 Hot melt adhesive
- 2 Stainless steel rod
- 3 Heat shrinkable tube

### Environmental Specifications

**Environmental Space** Indoor | Outdoor

### Packaging and Weights

**Packaging quantity** 100

**Packaging Type** Bag | Carton

### Regulatory Compliance/Certifications

Agency	Classification
CHINA-ROHS	Below maximum concentration value
ISO 9001:2015	Designed, manufactured and/or distributed under this quality management system
REACH-SVHC	Compliant as per SVHC revision on <a href="http://www.commscope.com/ProductCompliance">www.commscope.com/ProductCompliance</a>
ROHS	Compliant



## Home / All Products / Marker Posts / TriView®



# TriView®



The TriView® is the industry's best marker for creating awareness of buried facilities and reminding excavators to call before they dig. The triangular profile combined with the internal Flex PLUS™ rod makes the TriView® the most durable marker post available. In areas where livestock, wildlife, or vehicles are likely to impact signage, the TriView® will rebound to its upright position where other posts fail.



Watch our awesome impact video – it'll be the best 90 seconds you spend all day.

Starting At  
**\$21.20**

\*Online pricing may vary from Customer/Distributor pricing. Bulk quantity discounts if available show up in Cart/Checkout.

**BUY NOW**

### Description:

- Triangular post with colored cap
- 360-degree visibility
- Performs in temperatures ranging from -40 to +150°F
- Made with RhinoPoly® – our proprietary UV Stable, designed for 10+ years of outdoor use with our 10-year warranty

We use cookies on our website to give you the most relevant experience by remembering your preferences and repeat visits. By clicking "Accept", you consent to the use of ALL the cookies. .



**OPTIONS**

**SUPPORT VIDEOS**

**SUPPORT DOCUMENTS**

Lengths: 48" | 54" | 60" | 66" | 72" | 78" | 84" | 90"

**Standard Post Colors:**

-  Red
-  Orange
-  Yellow
-  Green
-  Blue
-  Purple
-  White
-  Brown

**Alternative Post Colors:**

-  Safety Green
-  Black
-  Pink
-  Tan

**Standard Cap Color:**

-  Black

We use cookies on our website to give you the most relevant experience by remembering your preferences and repeat visits. By clicking "Accept", you consent to the use of ALL the cookies.